

MAH JONG OUTDOOR - PLATEFORMES HPL

design Hans HOPFER

rochebobois
PARIS



MAH JONG OUTDOOR - PLATEFORMES HPL

design Hans HOPFER

rochebobo
PARIS

TISSUS MISSONI - COLLECTION OUTDOOR
MISSONI FABRICS - OUTDOOR COLLECTION / TELAS MISSONI - COLECCIÓN OUTDOOR



MAH JONG OUTDOOR - PLATEFORMES HPL

design Hans HOPFER

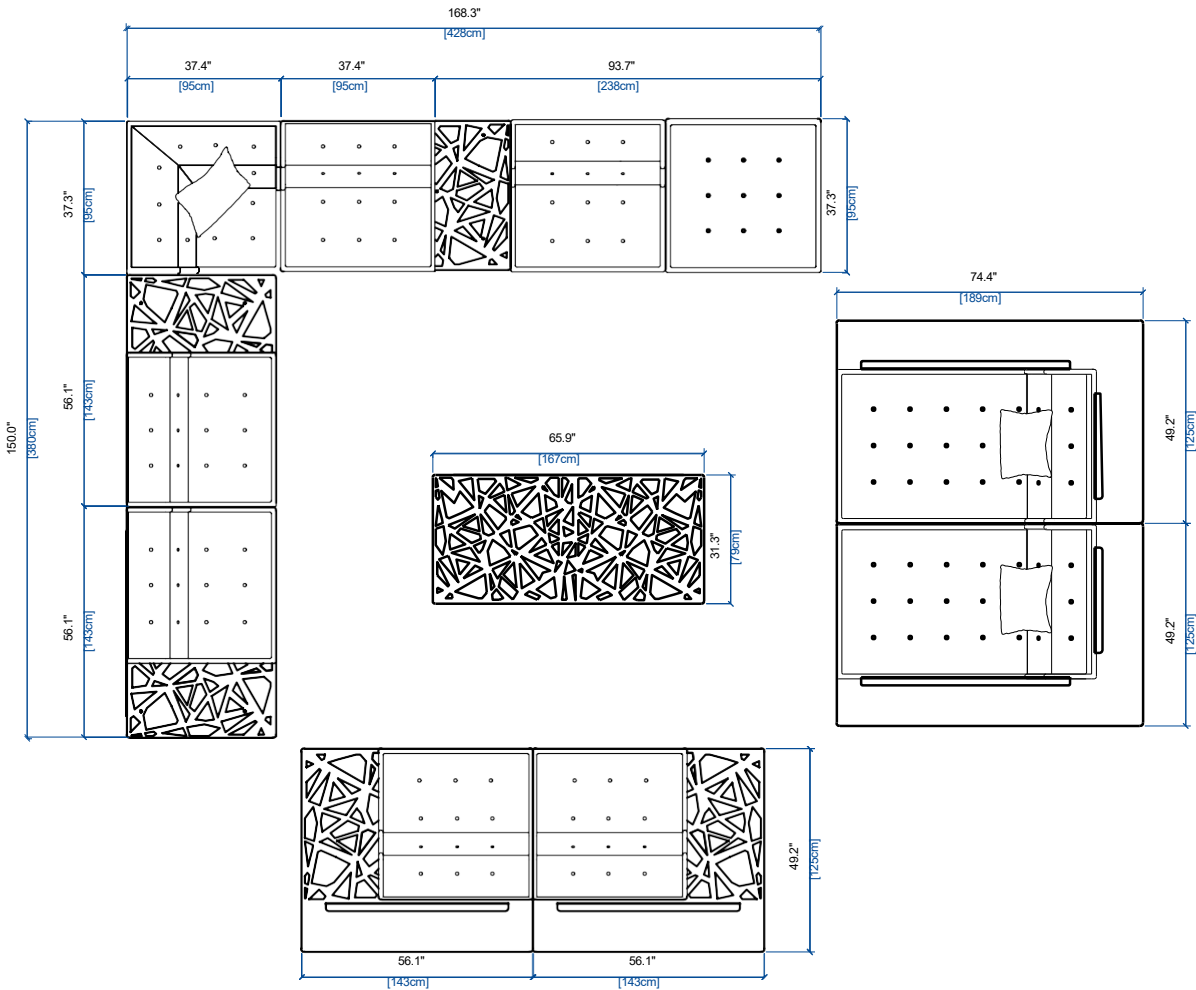

MAH JONG OUTDOOR - PLATEFORMES HPL

design Hans HOPFER

rochebobo
PARIS



MAH JONG OUTDOOR - PLATEFORMES HPL

design Hans HOPFER

rochebobo
PARIS

TISSUS JEAN PAUL GAULTIER OUTDOOR - COLLECTION AUTOUR DU MONDE

JEAN PAUL GAULTIER OUTDOOR FABRICS - AUTOUR DU MONDE COLLECTION / TELAS JEAN PAUL GAULTIER OUTDOOR - COLECCIÓN AUTOUR DU MONDE



MAH JONG OUTDOOR - PLATEFORMES HPL

design Hans HOPFER

rochebobois
PARIS

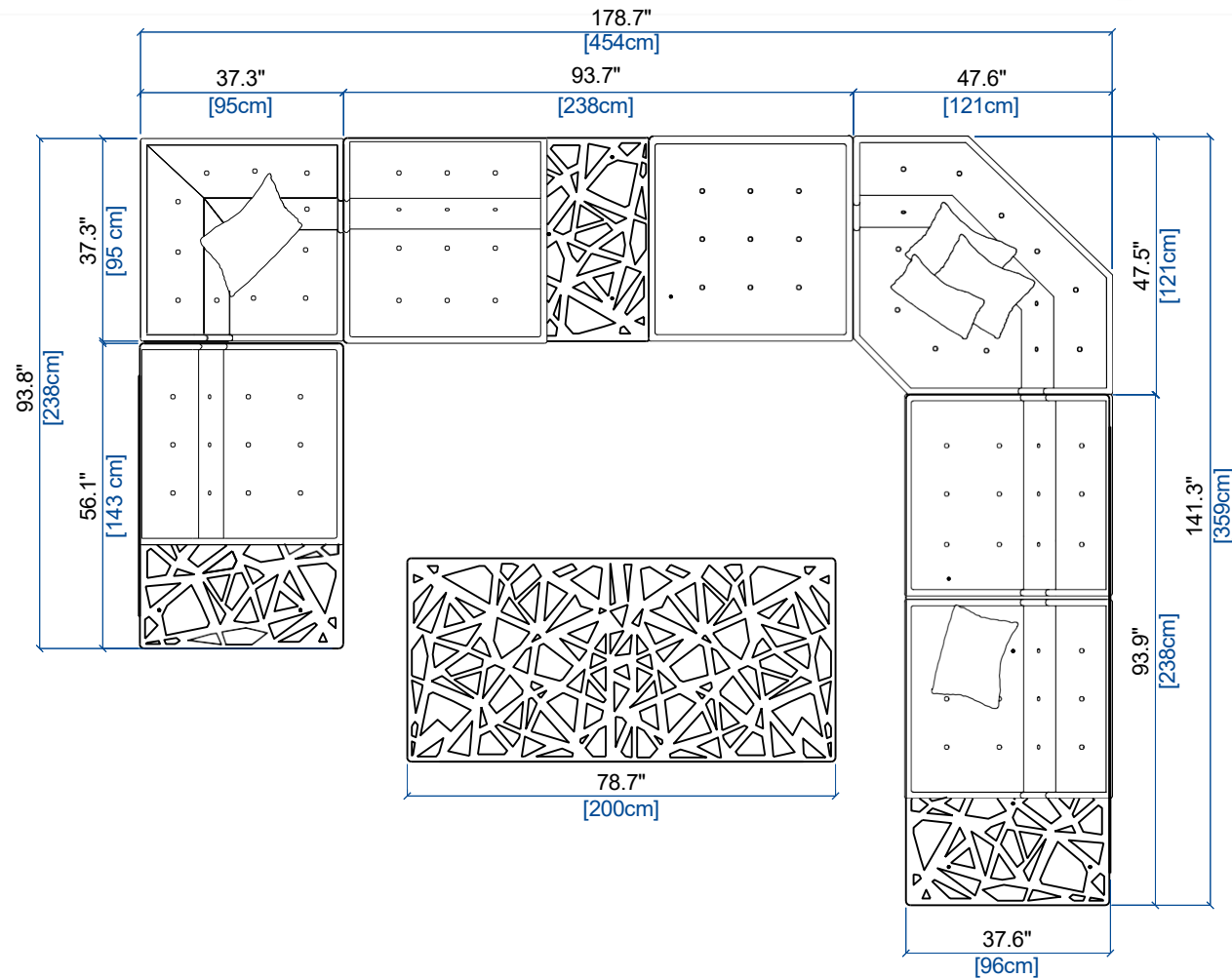
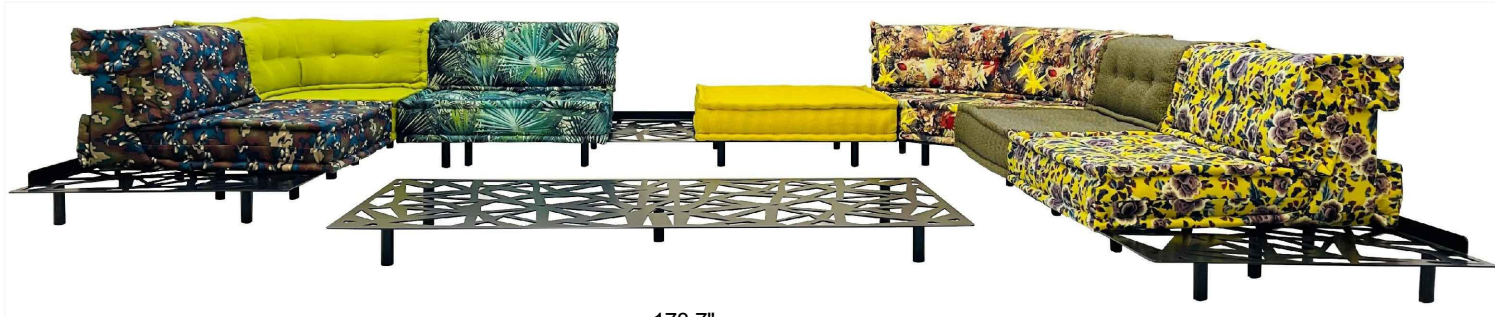

MAH JONG OUTDOOR - PLATEFORMES HPL

design Hans HOPFER

rochebobois
PARIS



MAH JONG OUTDOOR - PLATEFORMES HPL

design Hans HOPFER

rochebobo
PARIS

COLLECTION OUTDOOR TISSUS MISSONI ET UNIS OUTDOOR N°1
OUTDOOR COLLECTION MISSONI FABRICS AND UNIS OUTDOOR N°1 / COLECCIÓN OUTDOOR TELAS MISSONI Y UNIS OUTDOOR N°1



MAH JONG OUTDOOR - PLATEFORMES HPL

design Hans HOPFER

rochebobois
PARIS

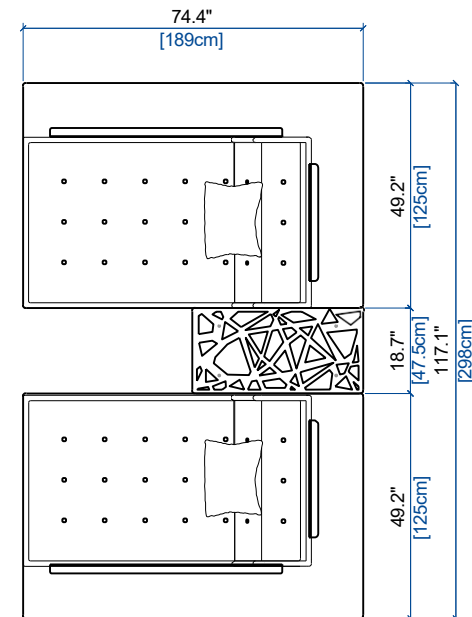
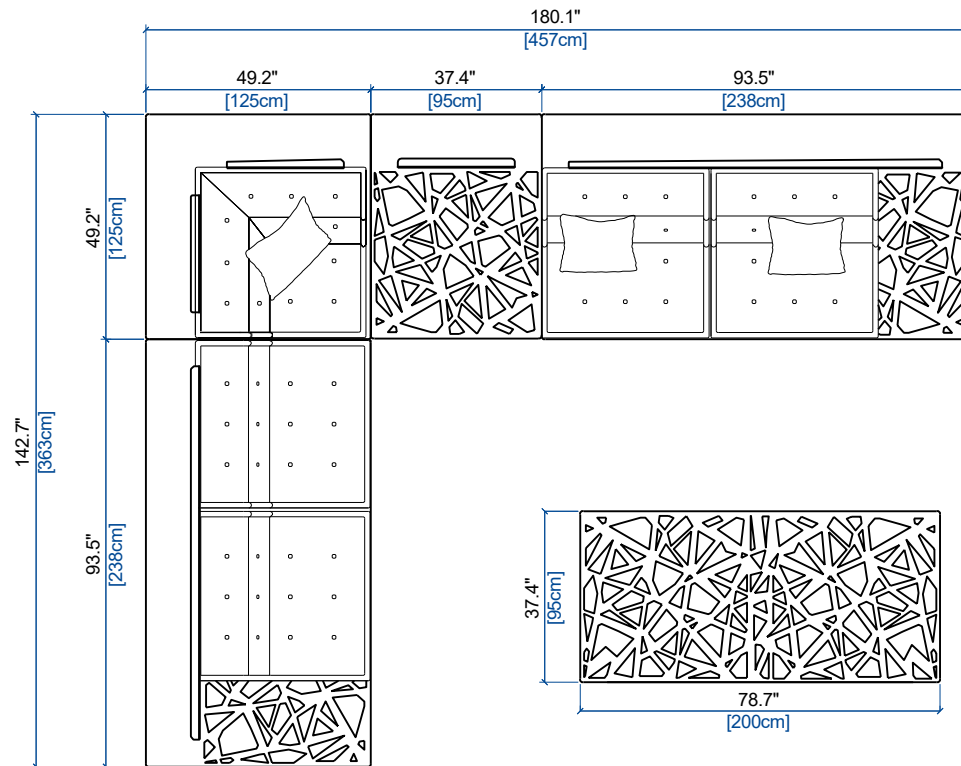

MAH JONG OUTDOOR - PLATEFORMES HPL

design Hans HOPFER

rochebobois
PARIS



INFORMATIONS TECHNIQUES / TECHNICAL SPECIFICATIONS / FICHA TECNICA :

Structure dossier bois FSC : Sapin massif, multiplis de pin (CARB) vernie à l'eau, traitée pour l'extérieur
 Coussin d'assise : Mousse polyuréthane Dryfeel (fermeture éclair en PVC)
 Coussin de dossier : Mousse polyuréthane Dryfeel (fermeture éclair en PVC)
 Petit coussin et Cale-reins : 100% fibre de polyester (fermeture éclair en PVC)
 Plateforme : HPL « High Pressure Laminate » / stratifié haute pression*
 Piétement avec patin réglable : Métal traité anticorrosion laqué

Back cushion structure FSC wood: Solid fir wood, pine plywood (CARB) with water-based varnish finish, treated for outdoor use
 Seat cushion: Polyurethane Dryfeel foam (PVC zipper)
 Back cushion: Polyurethane Dryfeel Foam (PVC zipper)
 Small cushion and Lumbar cushion: 100% polyester fibre (PVC zipper)
 Platform: HPL « High Pressure Laminate »*
 Base with adjustable pad: Lacquered metal with anti-corrosion coating

Estructura respaldo madera FSC: Abeto macizo, multilaminado de pino (CARB) barniz al agua y tratada para el exterior
 Cojín de asiento: Espuma de poliuretano Dryfeel (cremallera de PVC)
 Cojín de respaldo: Espuma de poliuretano Dryfeel (cremallera de PVC)
 Cojín pequeño y cojín riñonero: 100% fibra de poliéster (cremallera de PVC)
 Plataforma: HPL « High Pressure Laminate » / laminado de alta presión*
 Patas con base regulable : Metal lacado tratado anticorrosión

OBSERVATIONS / OBSERVATIONS / OBSERVACIONES :

- Fabrication Européenne
- Le service « sur-mesure » n'est pas disponible sur ce modèle
- Modèle réalisable dans les tissus outdoor de la collection ROCHE BOBOIS (collections JEAN PAUL GAULTIER OUTDOOR - AUTOUR DU MONDE, MISSONI OUTDOOR et UNIS OUTDOOR N°1), à l'exception des tissus extensibles
- Système modulaire composable à l'infini à partir de coussins d'assise, de dossiers droits et d'angle et d'éléments chaise longue
- Tous les éléments garnis sont capitonnés, matelassés et réalisés à la main
- Coutures faites à la main

- Manufactured in Europe
- Not customizable
- Model available in the outdoor fabrics from the ROCHE BOBOIS collection (collections JEAN PAUL GAULTIER OUTDOOR - AUTOUR DU MONDE, MISSONI OUTDOOR and UNIS OUTDOOR N°1), with the exception of stretch fabrics
- Modular system with endless combinations, including seat, straight and corner back cushions and lounge chair units
- All upholstered elements are padded, quilted and hand-made
- Hand-made stitching

- Fabricación europea
- El servicio "a medida" no es posible en este modelo
- Modelo realizable en las telas outdoor de la colección ROCHE BOBOIS (colecciones JEAN PAUL GAULTIER OUTDOOR - AUTOUR DU MONDE, MISSONI OUTDOOR y UNIS OUTDOOR N°1), con excepción de las telas elásticas
- Sistema modular componible hasta el infinito a partir de cojines de asiento, de respaldo rectos y de ángulo, y elementos de chaise longue
- Todos los elementos rellenos son capitonés, acolchados y realizados a mano
- Costuras cosidas a mano

OPTIONS / OPTIONAL / OPCIONES :

- Plateforme avec ou sans débord, table basse et tablette : HPL finition laquée, disponible en Blanc ou Noir, épaisseur 1 cm, tranche Noire (voir page 11)
- Piétement métal, finition laquée, disponible en Blanc, Gris ou Noir (voir page 12)
- Piétement disponible en 2 hauteurs, 14 cm ou 19 cm
- Petit coussin
- Coussin cale-reins
- Housse de protection thermocollée ouverte ou fermée
- Platform with or without protusion, rectangular table and cocktail table : HPL lacquered finish, available in White or Black, 1 cm thick, black slide (see page 11)
- Metal leg, lacquered finish, available in White, Grey or Black (see page 12)
- Legs available in 2 heights, 14 cm or 19 cm
- Small cushion
- Lumbar cushion
- Heat-sealed protective cover: open or closed
- Plataforma con o sin repisa, Mesa rectangular y Mesa pequeña : HPL acabado lacado, disponible en Blanco o Negro, 1 cm de grosor, en rodajas negras (ver página 11)
- Patas de metal, acabado lacado, disponible en Blanco, Gris o Negro (ver página 12)
- Patas disponible en 2 alturas, 14 cm o 19 cm
- Cojín pequeño
- Cojine riñonero
- Funda de protection termosellada: abierta o cerrada

* HPL : couches de fibres de bois et de papier imprégnées de résine thermosettable comprimées à haute pression et haute température / layers of wood fibers and paper impregnated with thermosetting resin compressed at high pressure and high temperature / capas de fibras de madera y papel impregnadas de resina termoendurecible comprimidas a alta presión y alta temperatura



La structure de ce canapé est certifiée FSC™ mixte. Elle est composée de matériaux provenant de forêts certifiées FSC™ gérées de façon responsable et d'autres sources contrôlées.
 This sofa's structure has FSC™ Mix certification. It is made with a mixture of materials from responsibly managed, FSC™-certified forests and from other controlled sources.
 La estructura de este sillón está certificada FSC™ mixto. Esta compuesta de materiales provenientes de bosques certificados FSC™ gestionados responsablemente y de otras fuentes controladas.

FINITIONS PLATEFORME EN HPL / HPL PLATFORM FINISHES / ACABADOS PLATAFORMA EN HPL

ASSISE / SEATS / ASIENTO



Laqué Blanc
White Lacquer
Lacado Blanco

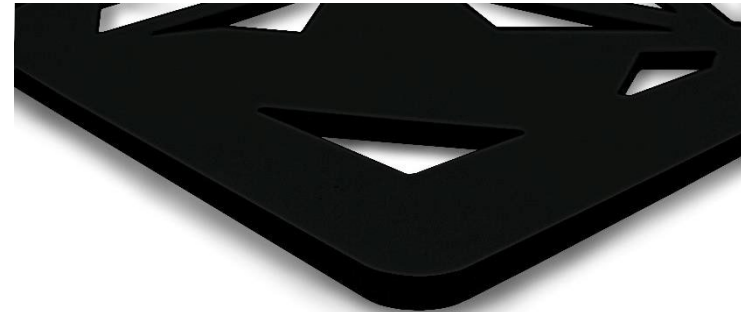

Laqué Noir
Black Lacquer
Lacado Negro

DOSSERET / BACKING / APOYO



Laqué Blanc
White Lacquer
Lacado Blanco



Laqué Noir
Black Lacquer
Lacado Negro

FINITIONS PIETEMENT / LEG FINISH / ACABADO PATAS



Laqué Gris
Grey Lacquer
Lacado Gris



Laqué Noir
Black Lacquer
Lacado Negro



Laqué Blanc
White Lacquer
Lacado Blanco

MAH JONG OUTDOOR - PLATEFORMES HPL

design Hans HOPFER

rochebobois
PARIS

ASSISE
SEAT CUSHION
COJIN DE ASIENTO

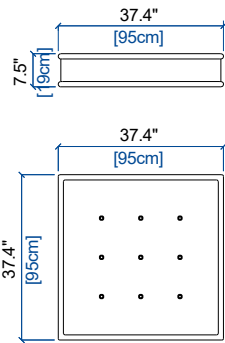

ASSISE CHAISE LONGUE
LOUNGE CHAIR SEAT CUSHION
ASIENTO CHAISE LONGUE

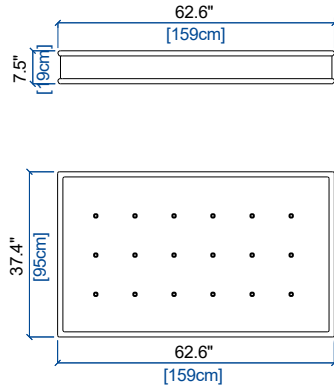

ASSISE D'ANGLE PANORAMIQUE
PANORAMIC CORNER SEAT CUSHION
ASIENTO PANORAMICO

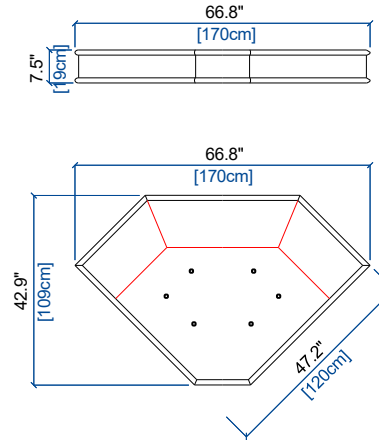

COUSSIN CALE-REIN
LUMBAR CUSHION
COJINO RINONERA

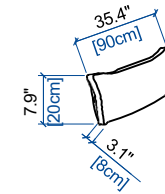

PETIT COUSSIN
SMALL CUSHION
COJIN PEQUEÑO

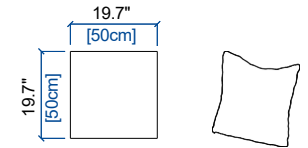

Coutures traversant l'assise / Stitching across the seat / Costuras que atraviesan el asiento

DOSSIER DROIT
STRAIGHT BACK CUSHION
COJIN DE RESPALDO RECTO

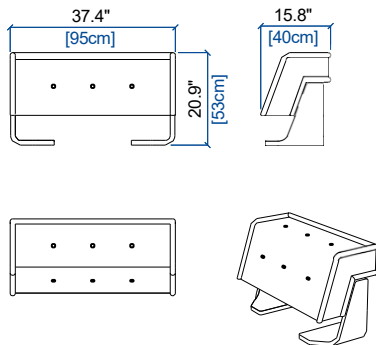

DOSSIER D'ANGLE
BACK CORNER CUSHION
COJIN DE RESPALDO DE ANGULO

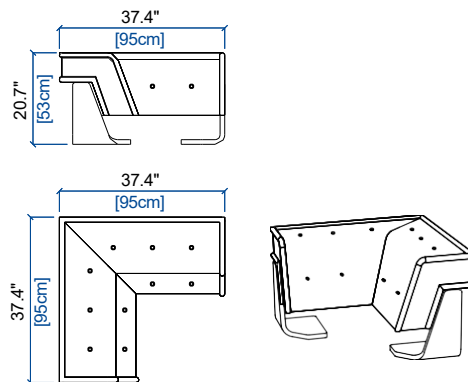

DOSSIER D'ANGLE PANORAMIQUE
PANORAMIC CORNER BACK CUSHION
RESPALDO DE ANGULO PANORAMICO

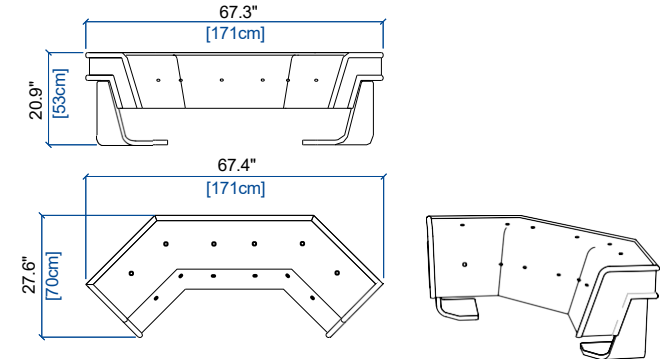

MAH JONG OUTDOOR - PLATEFORMES HPL

design Hans HOPFER

rochebobois
PARIS

PLATEFORME EN HPL AVEC DEBORD / HPL PLATFORM WITH PROTUSION PLATAFORMA DE HPL CON REPISA

364 PLATEFORME ASSISE 1 PLACE
1-SEAT PLATFORM
PLATAFORMA 1 PLAZA

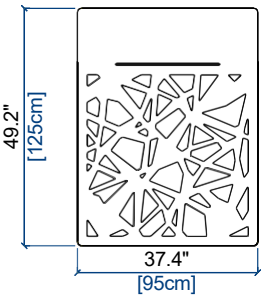
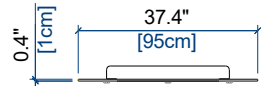

363 PLATEFORME ASSISE 1,5 PLACE
1.5-SEAT PLATFORM
PLATAFORMA 1,5 PLAZA

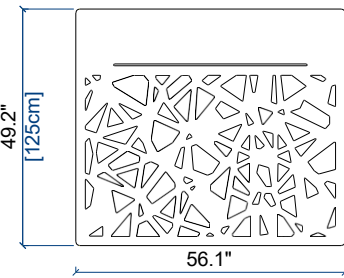
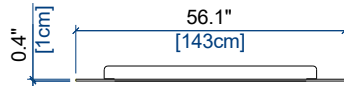

365 PLATEFORME ASSISE 2,5 PLACES
2.5-SEAT PLATFORM
PLATAFORMA 2,5 PLAZAS

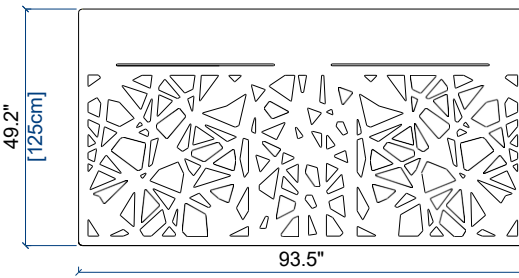
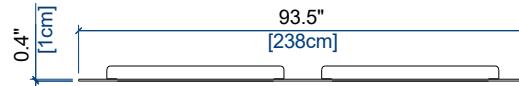

360 PLATEFORME CHAISE LONGUE GAUCHE
LOUNGE CHAIR LEFT PLATFORM
PLATAFORMA CHAISE LONGUE IZQ.

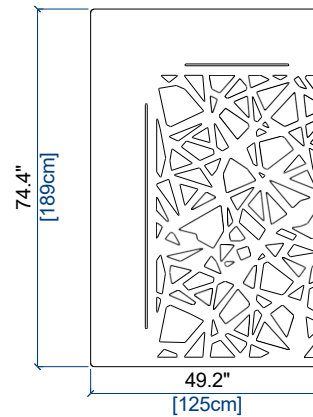
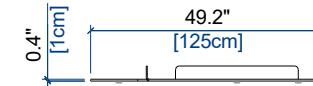

359 PLATEFORME CHAISE LONGUE DROITE
LOUNGE CHAIR RIGHT PLATFORM
PLATAFORMA CHAISE LONGUE DER.

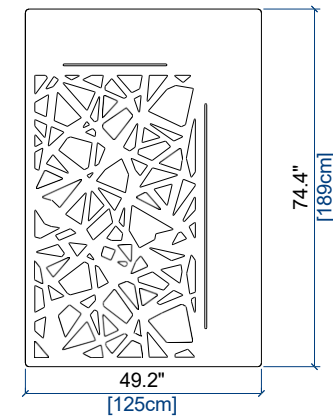
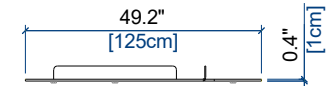

358 PLATEFORME ANGLE
CORNER SEAT PLATFORM
PLATAFORMA ANGULO

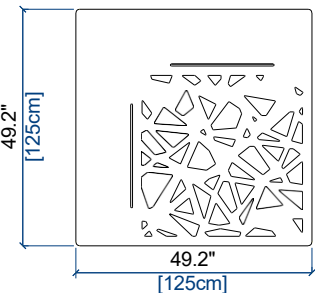
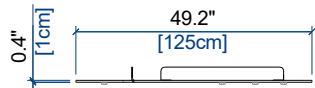

362 PLATEFORME TABLETTE
COCKTAIL TABLE PLATFORM
PLATAFORMA MESA PEQUEÑA

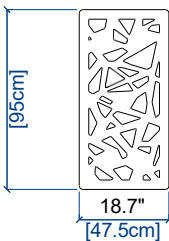
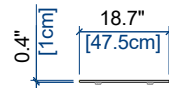

361 TABLE BASSE RECTANGULAIRE
RECTANGULAR TABLE
MESA RECTANGULAR

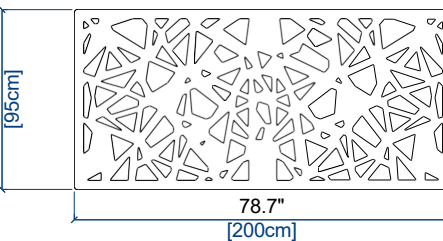
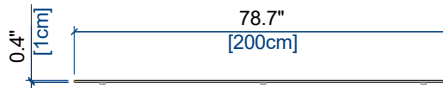

HAUTEURS DES PIETEMENTS
BASE HEIGHTS
ALTURA DE LAS PATAS

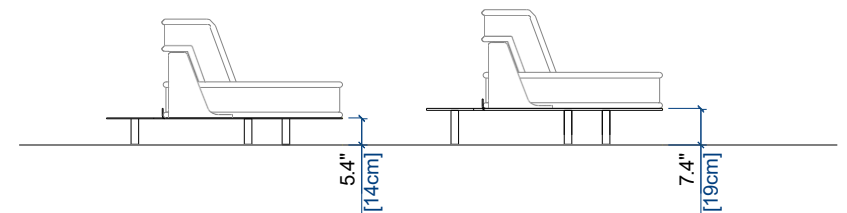

MAH JONG OUTDOOR - PLATEFORMES HPL

design Hans HOPFER

rochebobo
PARIS

PLATEFORME EN HPL SANS DEBORD / HPL PLATFORM WITHOUT PROTUSION PLATAFORMA DE HPL SIN REPISA

369

PLATEFORME ASSISE 1 PLACE
1-SEAT PLATFORM
PLATAFORMA 1 PLAZA

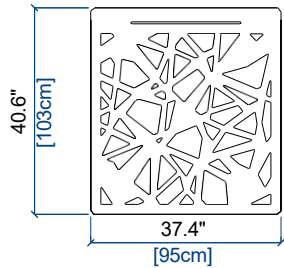
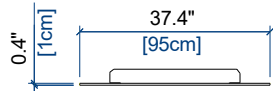

368

PLATEFORME ASSISE 1,5 PLACE
1.5-SEAT PLATFORM
PLATAFORMA 1,5 PLAZA

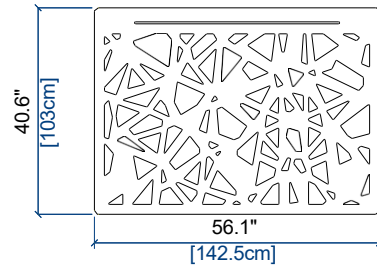
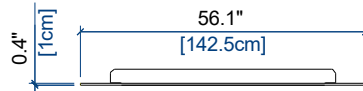

370

PLATEFORME ASSISE 2,5 PLACES
2.5-SEAT PLATFORM
PLATAFORMA 2,5 PLAZAS

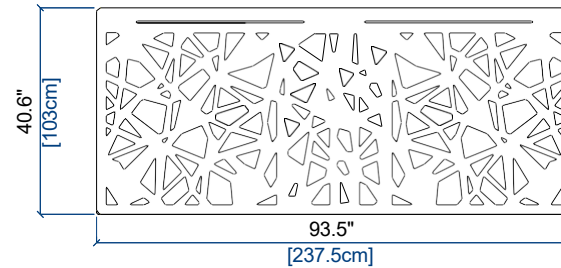
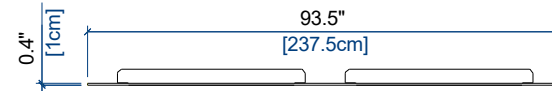

367

PLATEFORME CHAISE LONGUE
LOUNGE CHAIR PLATFORM
PLATAFORMA CHAISE LONGUE

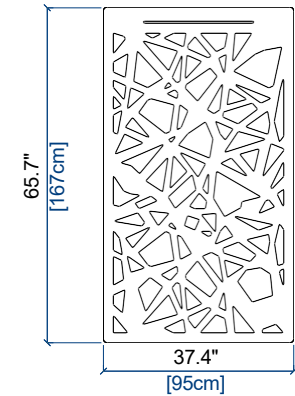
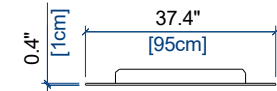

366

PLATEFORME ANGLE
CORNER SEAT PLATFORM
PLATAFORMA ANGULO

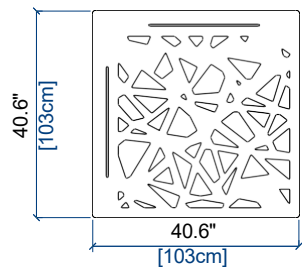
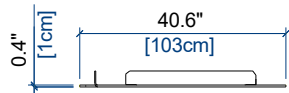

371

PLATEFORME ANGLE PANORAMIQUE
PANORAMIC CORNER PLATFORM
PLATAFORMA ANGULO PANORAMICO

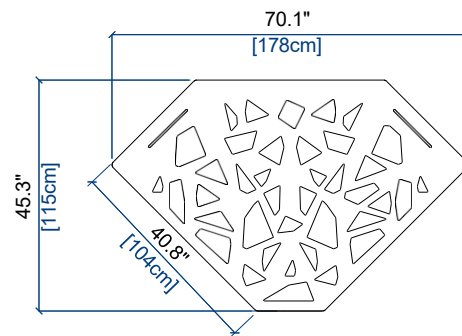
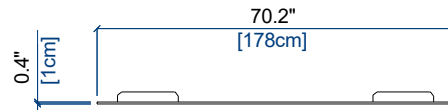

HAUTEURS DES PIETEMENTS
BASE HEIGHTS
ALTURA DE LAS PATAS

