

INTERVALLE

design Studio ROCHE BOBOIS

rochebobois
PARIS



INTERVALLE

design Studio ROCHE BOBOIS

rochebobois
PARIS



INTERVALLE

design Studio ROCHE BOBOIS

rochebobois
PARIS



COMPOSITION 3 ELEMENTS. L.290 x H.91 x P.99 cm

IN04 Bâtard 1 place acc. gauche L.100 + IN08 Chauffeuse L.90 + IN05 Bâtard 1 place acc. droit L.100

SOFA IN 3 PARTS (114" w x 36"h x 39"d)

IN04 1-SEAT 1 ARM UNIT LEFT ARMREST 39.5" + IN08 ARMLESS CHAIR 35.5" + IN05 1-SEAT 1 ARM UNIT RIGHT ARMREST 39.5"

COMPOSICIÓN SOFÁ 3 ELEMENTOS (L. 290 x H.91 x P.99 cm)

IN04 BATARD 1 PL L.100 cm APY IZQUIERDO + IN08 CHAUFFEUSE L.90 cm + IN05 BATARD 1 PL L.100 cm APY DERECHO

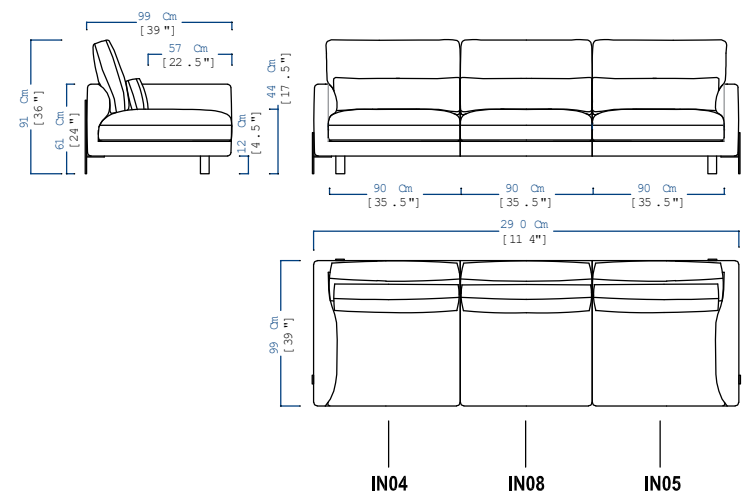

INTERVALLE

design Studio ROCHE BOBOIS

rochebobois
PARIS



INFORMATIONS TECHNIQUES / TECHNICAL SPECIFICATIONS / CARACTERISTICAS TECNICAS:

Structure bois FSC : Sapin massif, panneaux de particules (CARB)
Suspension : Sangles élastiques entrecroisées
Coussins d'assise : Mousse polyuréthane multi-densité 25-30-40-50 kg/m³ et résine 200 gr
Coussins d'assise Fauteuil : Mousse polyuréthane bi-densité 35-30 kg/m³ et résine 200 gr
Coussins de dossier et coussins déco : Plumes d'oie et canard et fibres polyester
Piétement : Métal laqué finition bronze foncé

FSC wood structure: Solid fir wood, particle board (CARB)
Suspension: Elastic straps cross webbing
Seat cushions: Multi-density polyurethane foam 25-30-40-50 kg/m³ and resin 200 gr
Armchair seat cushions: bi-density polyurethane foam 35-30 kg/m³ and resin 200 gr
Back and deco cushions: Goose and duck feathers and polyester fibers
Base: Lacquered metal in dark bronze finish

Estructura de madera FSC: Abeto macizo, paneles de partículas (CARB)
Suspensión: Cinchas elásticas entrecruzadas
Cojines de asiento: Espuma de poliuretano multidensidad 25-30-40-50 kg/m³ y resina 200g
Cojines del asiento del sillón: Espuma de poliuretano de doble densidad 35-30 kg/m³ y resina 200g
Cojines de respaldo y cojines decorativos: Plumas de oca y pato y fibras de poliéster
Patatas: Metal lacado acabado en bronce oscuro

OBSERVATIONS / OBSERVATIONS / OBSERVACIONES:

- Fabrication Européenne
- Modèle réalisable dans l'ensemble des revêtements de la collection Roche Bobois à l'exception des velours
- Made in Europe
- Model available in all materials from the ROCHE BOBOIS collection except for velvet
- Fabricacion europea
- Modelo realizable en todos los revestimientos de la colección Roche Bobois con excepción de los terciopelos

OPTIONS / OPTIONAL / OPCIONES :

- Confort normal ou ferme
- Coussins déco
- Standard or firm comfort
- Deco cushions
- Confort normal o firme
- Cojines decorativos



La structure de ce canapé est certifiée FSC™ mixte. Elle est composée de matériaux provenant de forêts certifiées FSC™ gérées de façon responsable et d'autres sources contrôlées.
This sofa's structure has FSC™ Mix certification. It is made with a mixture of materials from responsibly managed, FSC™ certified forests and from other controlled sources.
La estructura de este sofá esta certificada FSC™ mixto. Esta compuesta de materiales provenientes de bosques certificados FSC™ gestionados responsablemente y de otras fuentes controladas.

INTERVALLE

design Studio ROCHE BOBOIS

rochebobois
PARIS

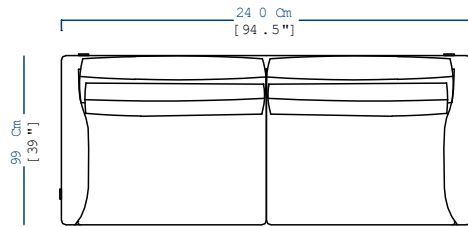
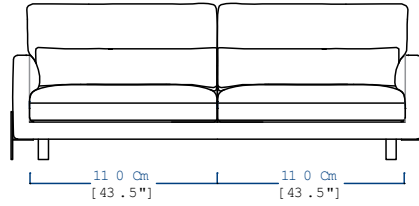
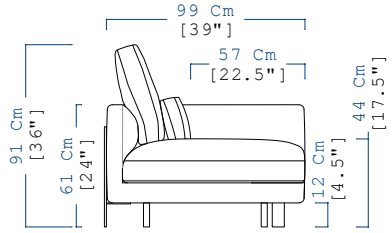

IN01
GRAND CANAPE 3 PLACES
LARGE 3 - SEAT SOFA
GRAN SOFÁ 3 PLAZAS

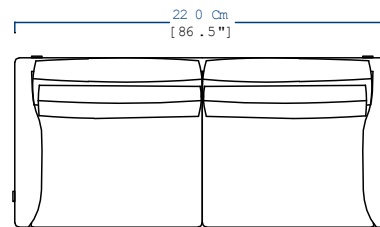
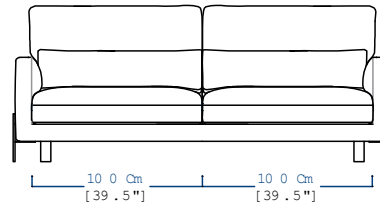

IN02
CANAPE 3 PLACES
3 - SEAT SOFA
SOFÁ 3 PLAZAS

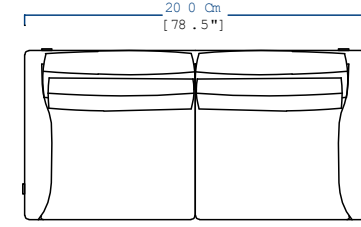
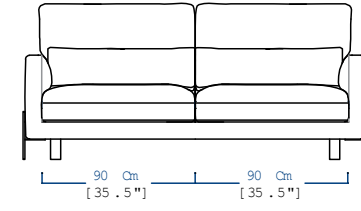

IN03
CANAPE 2 PLACES 1/2
2.5 - SEAT SOFA
SOFÁ 2 PLAZAS 1/2

INTERVALLE

design Studio ROCHE BOBOIS

rochebobo
PARIS

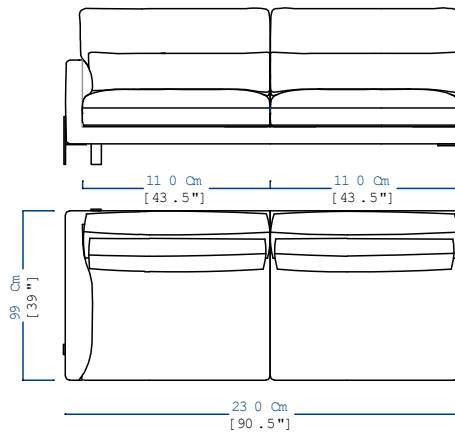
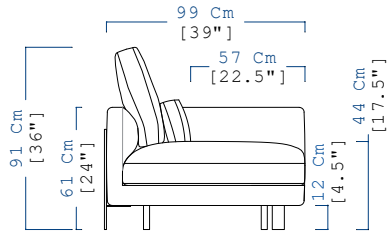

IN19
GRAND BATARD 3 PLACES ACC. GAUCHE
LARGE 3-SEAT 1-ARM UNIT LEFT ARMREST
GRAN BATARD 3 PL.APY IZQUIERDO

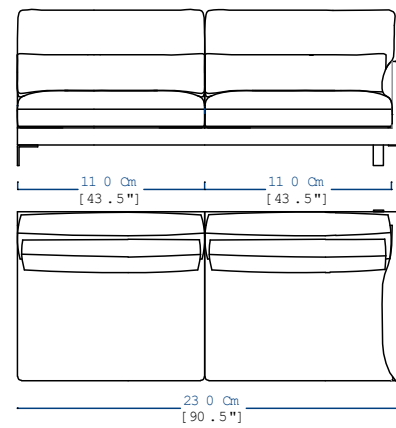

IN20
GRAND BATARD 3 PLACES ACC. DROIT
LARGE 3-SEAT 1-ARM UNIT RIGHT ARMREST
GRAN BATARD 3 PL.APY DERECHO

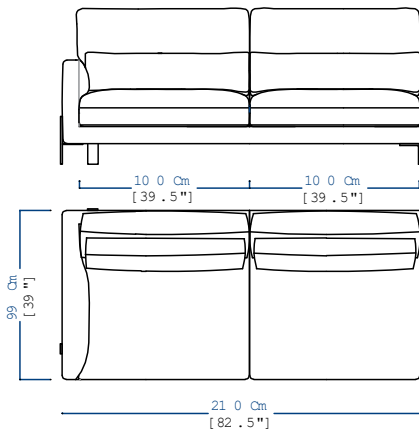

IN21
BATARD 3 PLACES ACC. GAUCHE
3-SEAT 1-ARM UNIT LEFT ARMREST
BATARD 3 PL.APY IZQUIERDO

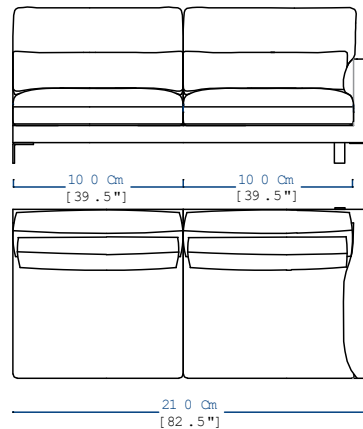

IN22
BATARD 3 PLACES ACC. DROIT
3-SEAT 1-ARM UNIT RIGHT ARMREST
BATARD 3 PL.APY DERECHO

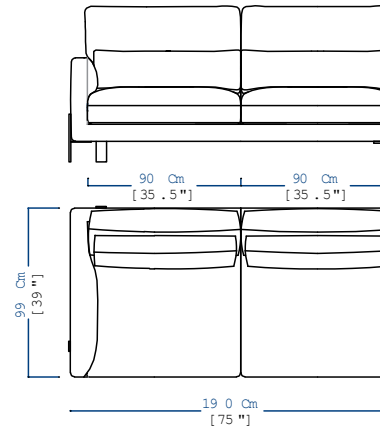

IN23
BATARD 2,5 PLACES ACC. GAUCHE
2,5-SEAT 1-ARM UNIT LEFT ARMREST
BATARD 2,5 PL.APY IZQUIERDO

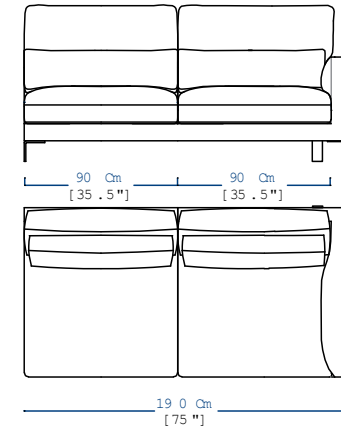

IN24
BATARD 2,5 PLACES ACC. DROIT
2,5-SEAT 1-ARM UNIT RIGHT ARMREST
BATARD 2,5 PL.APY DERECHO

INTERVALLE

design Studio ROCHE BOBOIS

rochebobo
PARIS

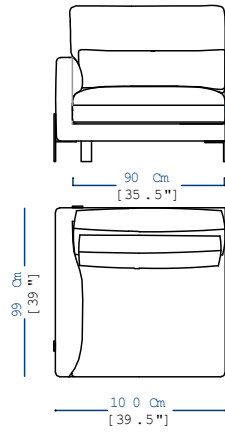
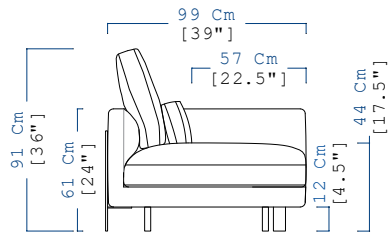

IN04
BATARD 1 PLACE GAUCHE
1-SEAT 1-ARM UNIT LEFT ARMREST
BATARD 1 PL. APY. IZQUIERDO

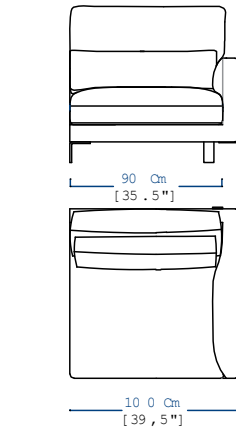

IN05
BATARD 1 PLACE DROIT
1-SEAT 1-ARM UNIT RIGHT ARMREST
BATARD 1 PL. APY. DERECHO

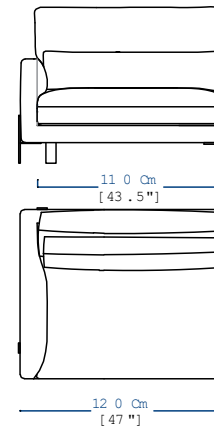

IN06
BATARD 1 PLACE GAUCHE
1-SEAT 1-ARM UNIT LEFT ARMREST
BATARD 1 PL. APY. IZQUIERDO

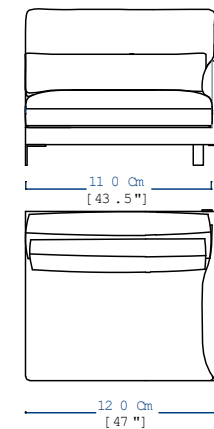

IN07
BATARD 1 PLACE DROIT
1-SEAT 1-ARM UNIT RIGHT ARMREST
BATARD 1 PL. APY. DERECHO

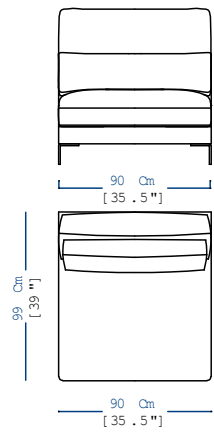
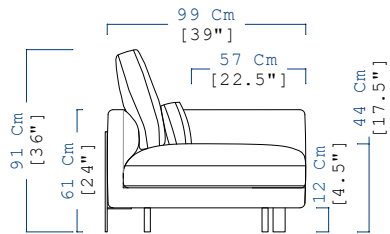

IN08
CHAUFFEUSE
ARMLESS CHAIR
CHAUFFEUSE

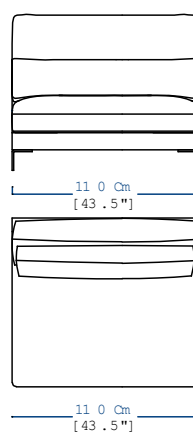

IN09
CHAUFFEUSE
ARMLESS CHAIR
CHAUFFEUSE

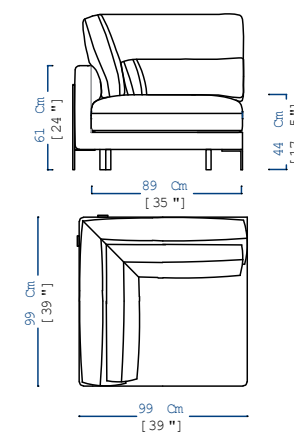
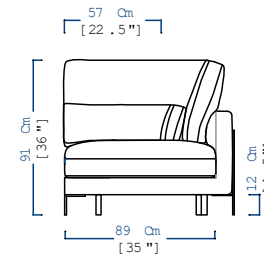

IN10
ANGLE CARRE
SQUARE CORNER
ANGULO CUADRADO

INTERVALLE

design Studio ROCHE BOBOIS

rochebobois
PARIS

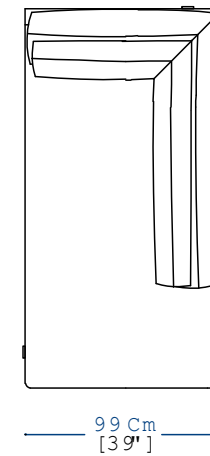
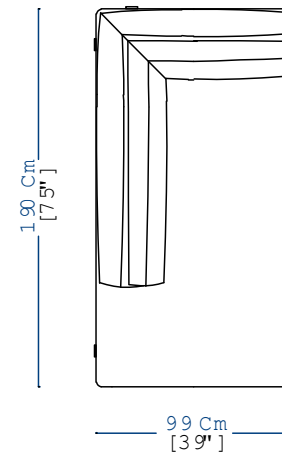
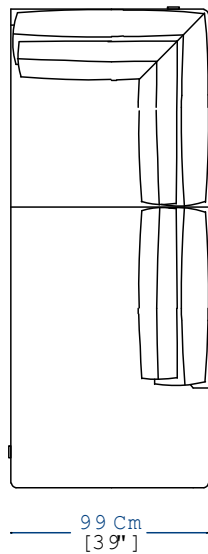
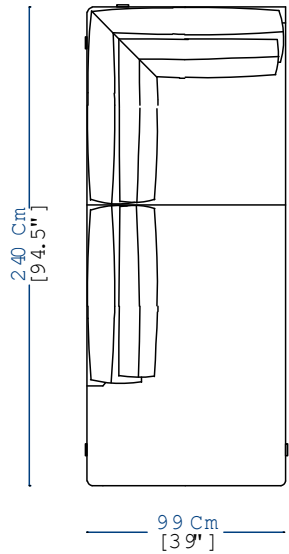
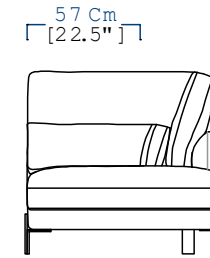
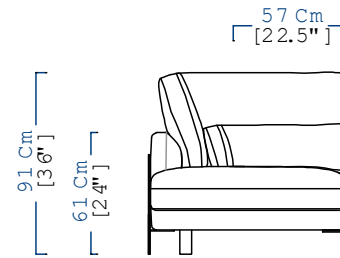
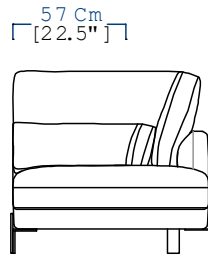
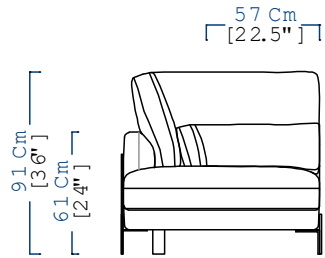
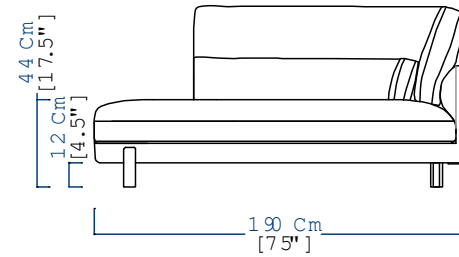
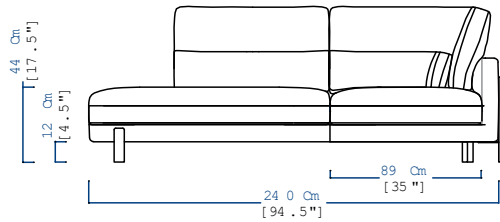

IN11
GRAND ANGLE/MERIDIENNE GAUCHE
LARGE CORNER/MERIDIENNE LEFT
GRANDE ANGULO/MERIDIENNE IZQUIERDO

IN12
GRAND ANGLE/MERIDIENNE DROITE
LARGE CORNER/MERIDIENNE RIGHT
GRANDE ANGULO/MERIDIENNE DERECHO

IN13
ANGLE/MERIDIENNE GAUCHE
CORNER/MERIDIENNE LEFT
ANGULO/MERIDIENNE IZQUIERDO

IN14
ANGLE/MERIDIENNE DROITE
CORNER/MERIDIENNE RIGHT
ANGULO/MERIDIENNE DERECHO

INTERVALLE

design Studio ROCHE BOBOIS

rochebobo
PARIS

