

TEMPS CALME OUTDOOR

design Studio ROCHE BOBOIS

rochebobo
PARIS



FICHE TECHNIQUE / TECHNICAL SPECIFICATIONS / FICHA TECNICA:

Structure bois FSC : Okoumé massif et multiplis d'okoumé (CARB)
Suspension : Sangles élastiques
Garnissage assise : Mousse polyuréthane DRYFEEL densité MS et fibre polyester
Garnissage dossier : Mousse polyuréthane DRYFEEL bi-densité XS/MS et fibre polyester
Piètement : Polypropylène régénéré, finition Noir avec système anti-dérapant

FSC wood structure: Solid okoume wood and okoume plywood (CARB)
Suspension: Elastic straps
Seat cushion: DRYFEEL polyurethane foam MS and polyester fibre
Back cushion: Bi-density DRYFEEL polyurethane foam XS/MS and polyester fibre
Base: Regenerated polypropylene, Black finish with anti-slip system

Estructura madera FSC: Okume macizo y multilaminado de okume (CARB)
Suspensión: Cinchas elásticas
Cojines de asiento: Espuma poliuretano DRYFEEL densidad MS y fibra poliéster
Cojines de respaldo: Espuma poliuretano DRYFEEL densidad XS/MS y fibra poliéster
Patatas: Polipropileno regenerado, acabado Negro con sistema antideslizante

OBSERVATIONS / OBSERVATIONS / OBSERVACIONES:

- Fabrication Européenne
- Entièrement déshabillable
- L'Okoumé étant un bois marin naturellement résistant à l'eau, il n'a pas besoin de traitement spécifique pour le rendre utilisable en extérieur
- Modèle réalisable dans les tissus outdoor de la collection ROCHE BOBOIS : Equateur, Méridien uni, Méridien matelassé, Sunrise, Taormina, tissus Jean Paul Gaultier collection « Autour du Monde » et tissu Missoni outdoor, à l'exception des tissus avec raccords
- Modèle destiné à une utilisation à l'extérieur
- Modèle non réalisable en cuir

- Made in Europe
- Entirely removable covers
- Okoume is a marine wood naturally resistant to water, it does not require a specific treatment to make it suitable for outdoor use
- Model available in the outdoor fabrics from the ROCHE BOBOIS collection: Equateur, Méridien Uni, Méridien Matelassé, Sunrise, Taormina, "Autour Du Monde" Jean Paul Gaultier Outdoor collection fabrics, and Missoni outdoor fabrics, with the exception of the fabrics with repeat
- Model for outdoor use
- Model not available in leather

- Fabricación Europea
- Completamente desfundable
- El Okume es una madera marina naturalmente resistente al agua, por lo que no necesita un tratamiento específico para que pueda utilizarse en exteriores
- Modelo realizable en las telas outdoor de la colección ROCHE BOBOIS: Equateur, Méridien Uni, Méridien Matelassé, Sunrise, Taormina, telas Jean Paul Gaultier collection "Autour Du Monde" y telas Missoni outdoor, excepto con las telas con racords
- Modelo para uso en exteriores
- Modelo no disponible en piel

OPTIONS / OPTIONS / OPCIONES:

- Pour les tissus Equateur, Méridien Uni et Méridien Matelassé, coutures disponibles en fil tressé dans les combinaisons de coloris indiquées aux pages 5 et 6, ou fil épais ton sur ton
- Coussin cale-reins et coussins déco
- Housses de protection thermosoudées en polyester

- For the Equateur, Méridien Uni, and Méridien Matelassé fabrics, stitching available with braided thread in the combinations of colours of pages 5 et 6, or tone-on-tone thick thread
- Lumbar cushion and decorative cushions
- Thermo-sealed protective polyester covers

- Para las telas Equateur, Méridien Uni y Méridien Matelassé, costuras disponibles en hilo trenzado en las combinaciones indicadas en las páginas 5 y 6 o hilo grueso tono sobre tono
- Riñonera y cojines decorativos
- Fundas de protección termoselladas en poliéster



La structure de ce canapé est certifiée FSC™ mixte. Elle est composée de matériaux provenant de forêts certifiées FSC™ gérées de façon responsable et d'autres sources contrôlées.
This sofa's structure has FSC™ Mix certification. It is made with a mixture of materials from responsibly managed, FSC™-certified forests and from other controlled sources.

La estructura de este sofá está certificada FSC™ mixto. Está compuesta de materiales provenientes de bosques certificados FSC™ gestionados responsablemente y de otras fuentes controladas.

TEMPS CALME OUTDOOR

design Studio ROCHE BOBOIS

rochebobo
PARIS

14 Chauffeuse
Armless chair
Chauffeuse

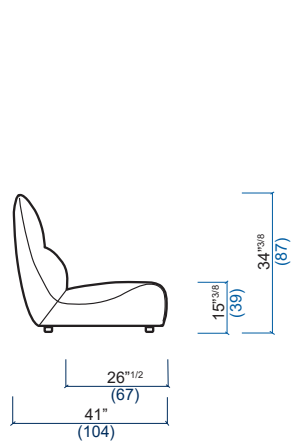

21 Chauffeuse
Armless chair
Chauffeuse

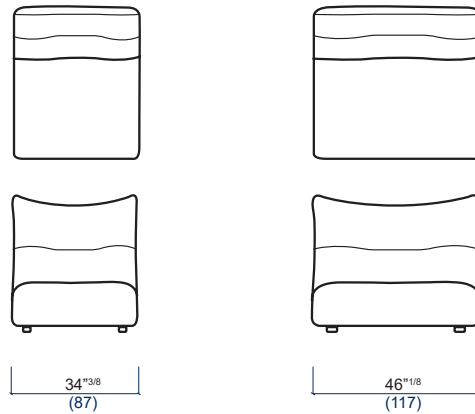

54 Chaise longue
Lounge chair
Chaise longue

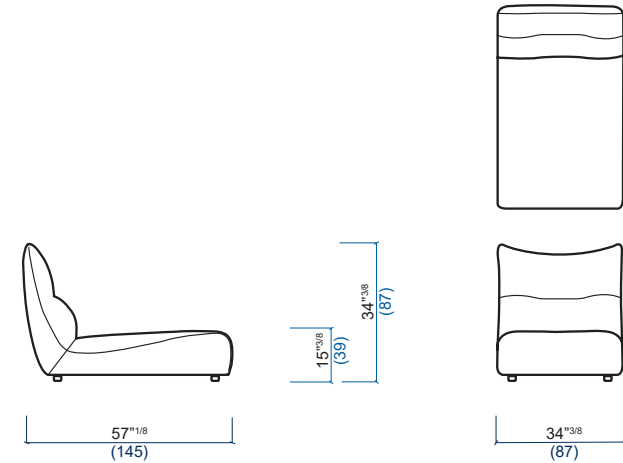

50 Angle carré
Square corner
Angulo cuadrado

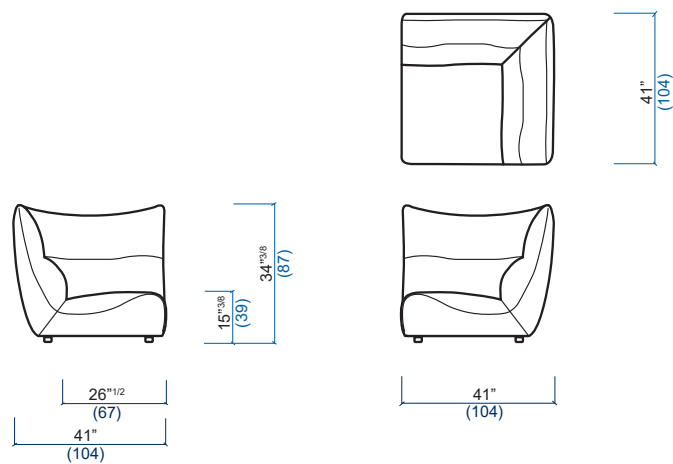

TEMPS CALME OUTDOOR

design Studio ROCHE BOBOIS

rochebobo
PARIS

40 Pouf carré
Square ottoman
Puf cuadrado

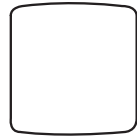

45 Pouf rectangulaire
Rectangular ottoman
Puf rectangular

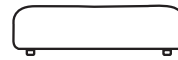
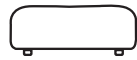
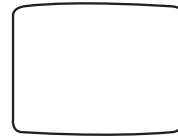

99 Coussin carré
Square cushion
Cojín cuadrado



98 Coussin rectangulaire
Rectangular cushion
Cojín rectangular

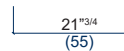

97 Cale-reins
Lumbar cushion
Rifionera

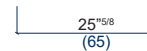

HOUSES DE PROTECTION / PROTECTIVE COVERS / FUNDAS DE PROTECCIÓN

H14 Housse de protection pour Chauffeuse L.87
Protective cover for Armless chair L.87
Funda de protección para Chauffeuse L.87

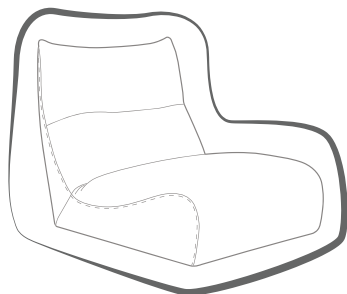

H21 Housse de protection pour Chauffeuse L.117
Protective cover for Armless chair L.117
Funda de protección para Chauffeuse L.117

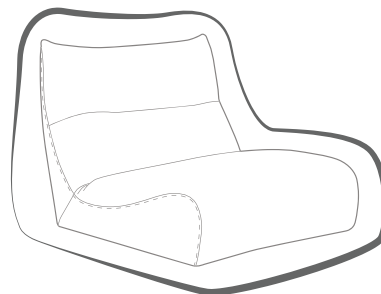

H54 Housse de protection pour Chaise longue
Protective cover for Lounge chair
Funda de protección para Chaise longue

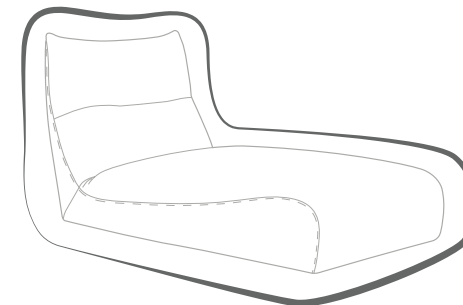

H50 Housse de protection pour Angle carré
Protective cover for Square corner
Funda de protección para Angulo cuadrado

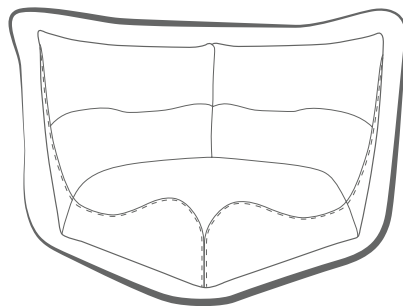

H40 Housse de protection pour Pouf carré
Protective cover for Square ottoman
Funda de protección para Puf cuadrado

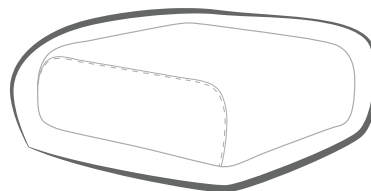

H45 Housse de protection pour Pouf rectangulaire
Protective cover for Rectangular ottoman
Funda de protección para Puf rectangulaire

