

Collection ALLIAGE

design Andrea CASATI

rochebobois
PARIS



Le piétement central de ce modèle est constitué d'un faisceau de lames d'acier taillées en trapèzes, groupés au sol et s'évasant dans une disposition particulière qui crée des perspectives sans cesse renouvelées. Son plateau est réalisé en composite céramique/verre (nombreuses finitions).

The central base of this model is made up of an array of steel blades cut into trapeziums, grouped on the ground and flaring out in a particular arrangement that constantly creates renewed perspectives. Its top is made of ceramic/glass composite (many finishes).

La base central de este modelo está formada por un haz de láminas de acero cortadas en forma de trapecio, agrupadas en el suelo y ensanchadas en una particular disposición que crea perspectivas constantemente renovadas. Su sobre está realizado en composite de cerámica/vidrio (varios acabados).

Collection ALLIAGE

design Andrea CASATI

rochebobois
PARIS



Collection ALLIAGE Tonneau - Barrel Shaped - Tonel

design Andrea CASATI

rochebobo
PARIS



Cette version en forme de tonneau devient un superbe ovale quand les deux rallonges se déploient. L'ovale fixe correspondant aux dimensions avec rallonges déployées existe aussi.

This barrel-shaped version transforms into a beautiful oval when the two extensions unfold. The fixed oval corresponding to the dimensions with extensions also exists.

Esta versión en forma de tonel se convierte en un hermoso óvalo cuando se despliegan las dos extensiones. También existe el óvalo fijo correspondiente a las medidas con extensiones extendidas.



Collection ALLIAGE Tonneau - Barrel Shaped - Tonel

design Andrea CASATI

rochebobois
PARIS



Table de repas avec plateau de forme tonneau et deux allonges de 40 cm la transformant en ovale réalisés en composite céramique/verre (nombreuses finitions). Traverse en aluminium et piétement en acier finition laque époxy.
Fabrication européenne.

Dining table with barrel-shaped top and two 40 cm extensions transforming it into an oval made of ceramic composite / glass (many finishes available). Aluminum crossbar and steel base with epoxy lacquer finish.

Manufactured in Europe

Mesa de comedor con sobre en forma de tonel y dos extensiones de 40 cm que la transforman en un óvalo realizada en composite cerámica/cristal (varios acabados). Travesaño de aluminio y base de acero con acabado lacado epoxi.
Fabricación europea.

Collection ALLIAGE Tonneau - Barrel Shaped - Tonel

design Andrea CASATI

rochebobo
PARIS

Table de repas Tonneau - 2 allonges
Ovale Dining table Barrel/Oval - 2 extension leaves
Mesa de comedor Tonel/Oval - 2 extensiones

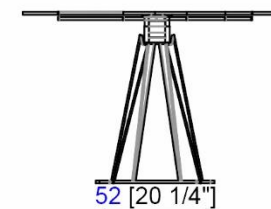
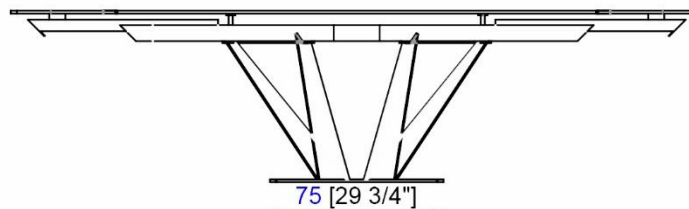
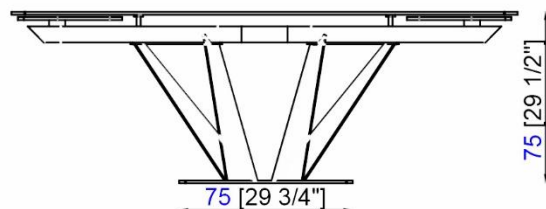
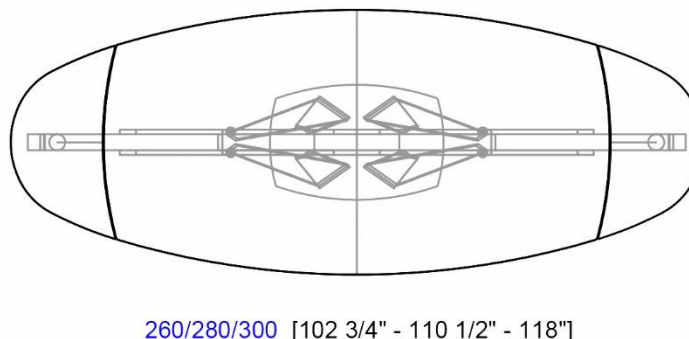
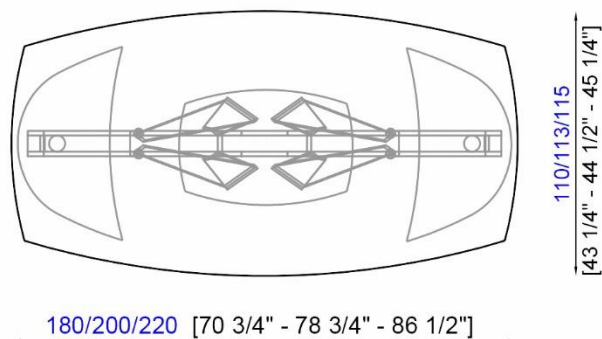

Collection ALLIAGE

Ovale Fixe - Oval Fixed - Oval Fija

sign Andrea CASATI

rochebobois
PARIS

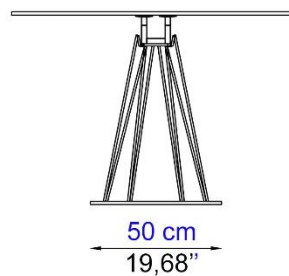
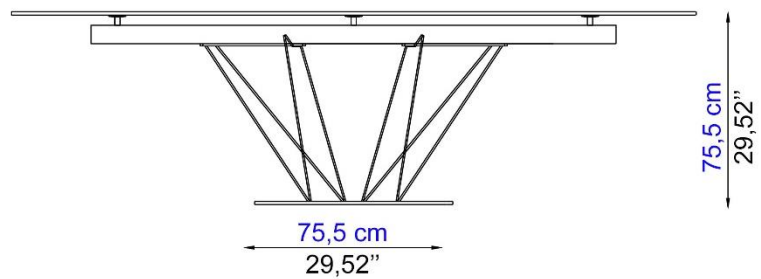
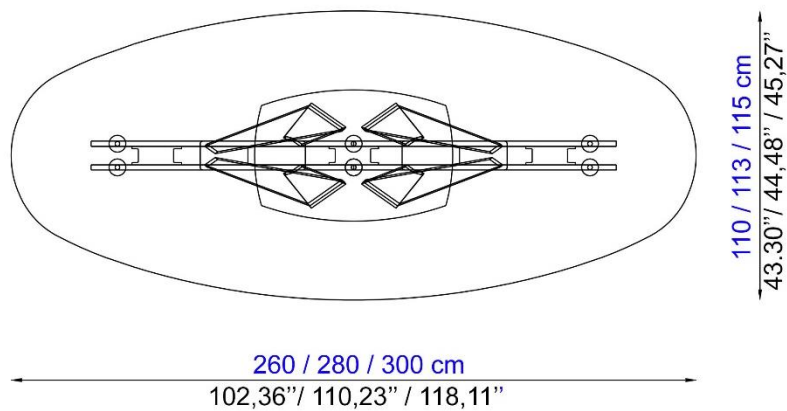

Collection ALLIAGE Tonneau - Barrel Shaped - Tonel

design Andrea CASATI

rochebobo
PARIS

Finitions disponibles - Finishes availables - Abacados disponibles

Céramiques 5 mm

Pietra

finitions mates / matte finishes
Acabados mate

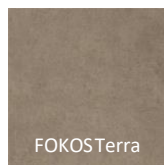
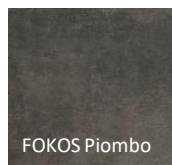

Marmi

finitions brillantes - glossy finishes
Acabados brillantes

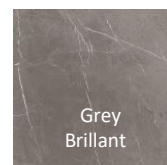
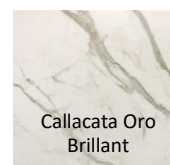
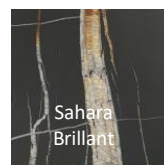
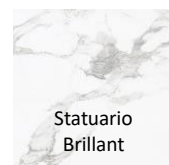
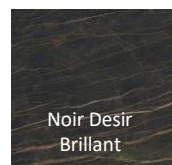

Marmi

finitions mates / matte finishes
Acabados mate



Absolu

finitions mates / matte finishes
Acabados mate

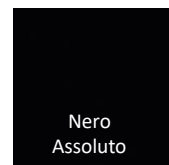

Céramiques 6 mm

Marmi

finitions brillantes - glossy finishes
Acabados brillantes

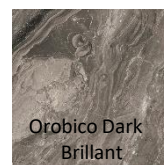
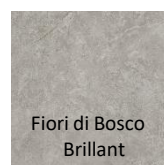

Marmi

finitions mates / matte finishes
Acabados mate

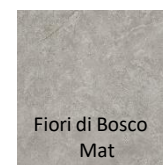

Collection ALLIAGE Rectangulaire - Rectangular - Rectangular

design Andrea CASATI

rochebobo
PARIS

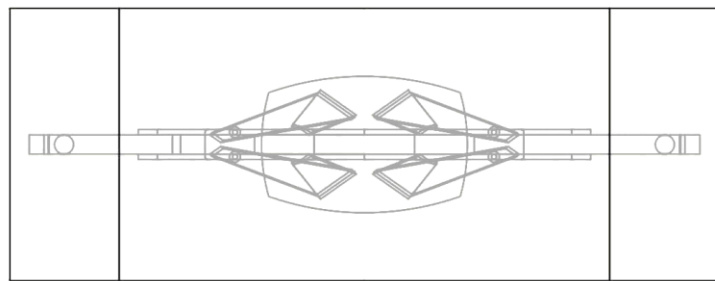

260/280/300 [102 1/4"-110 1/4"-118"]

100 [39 1/4"]

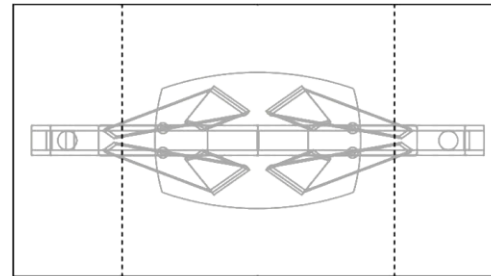

180/200/220 [70 3/4"-78 3/4"-86 1/2"]

100 [39 1/4"]

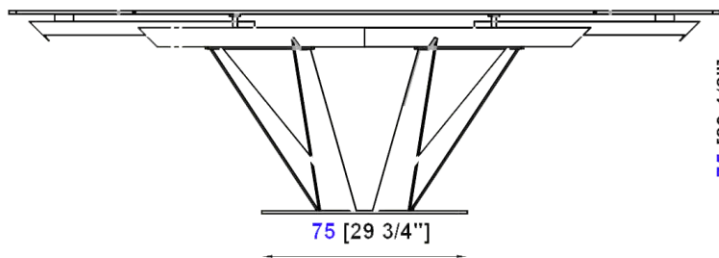

75 [29 1/2"]

75 [29 3/4"]

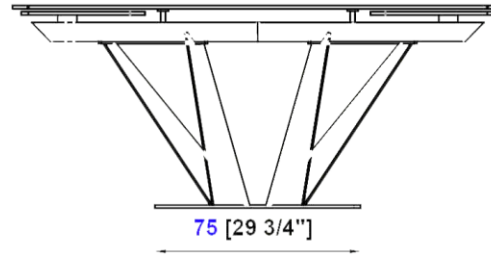

75 [29 3/4"]

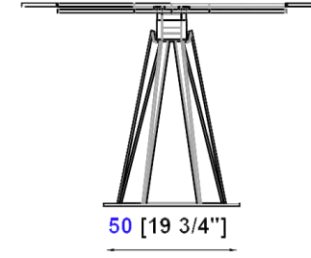

50 [19 3/4"]

Collection ALLIAGE Rectangulaire Fixe - Rectangular Fixed - Rectangular Fija

design Andrea CASATI

rochebobo
PARIS

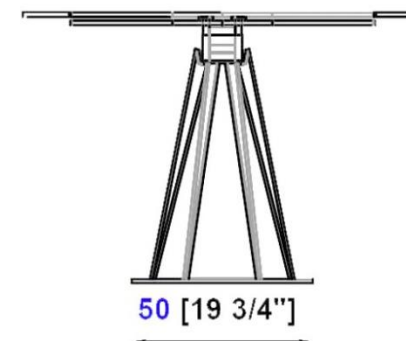
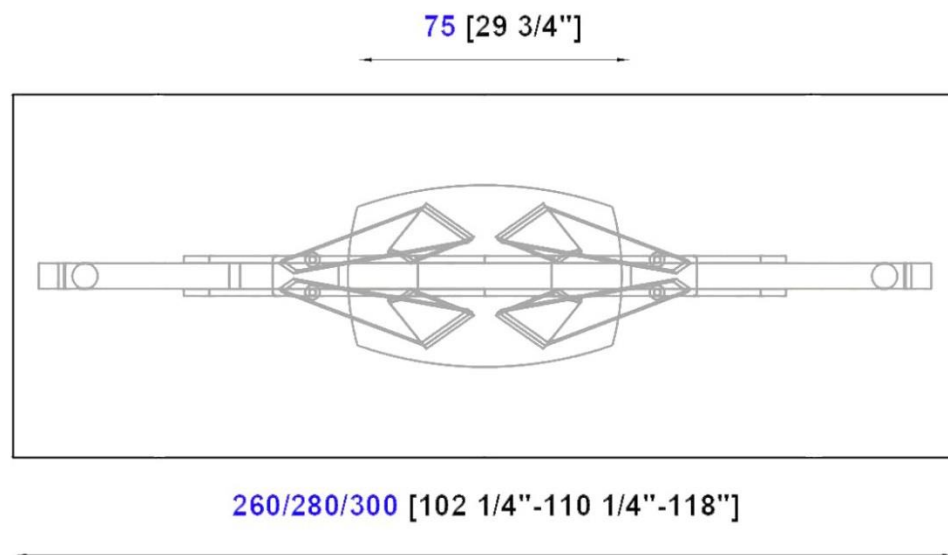

Collection ALLIAGE Rectangulaire - Rectangular - Rectangular

design Andrea CASATI

rochebobois
PARIS

Finitions disponibles - Finishes availables - Abacados disponibles

Céramiques 3 mm

Pietra

finitions mates / matte finishes
Acabados mate

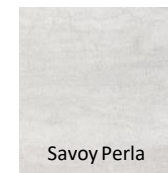
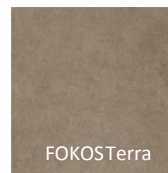
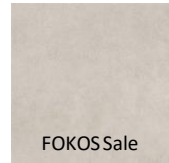
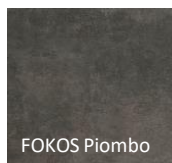

Céramiques 5 mm

Marmi

finitions brillantes - glossy finishes
Acabados brillantes

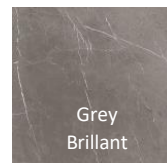
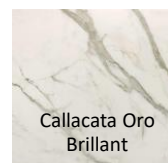
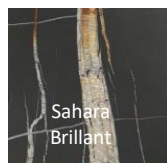
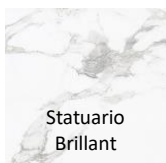
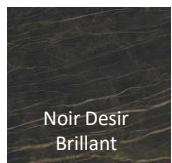

Marmi

finitions mates / matte finishes
Acabados mate



Absolu

finitions mates / matte finishes
Acabados mate

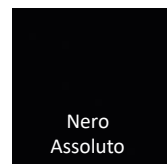

Céramiques 6 mm

Marmi

finitions brillantes - glossy finishes
Acabados brillantes

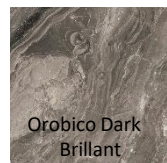

Marmi

finitions mates / matte finishes
Acabados mate



Collection ALLIAGE Rondes - Round - Ronda

design Andrea CASATI

rochebobois
PARIS



Le piétement central de ce modèle est constitué d'un faisceau de lames d'acier taillées en trapèzes, groupés au sol et s'évasant dans une disposition particulière qui crée des perspectives sans cesse renouvelées. Son plateau est réalisé en composite céramique/verre (nombreuses finitions).

The central base of this model is made up of an array of steel blades cut into trapeziums, grouped on the ground and flaring out in a particular arrangement that constantly creates renewed perspectives. Its top is made of ceramic/glass composite (many finishes)..

La base central de este modelo está formada por un haz de láminas de acero cortadas en forma de trapecio, agrupadas en el suelo y ensanchadas en una particular disposición que crea perspectivas constantemente renovadas. Su sobre está realizado en composite de cerámica/vidrio (varios acabados).

Collection ALLIAGE Rondes - Round - Ronda

design Andrea CASATI

rochebobo
PARIS



En version ronde, elle peut s'agrémenter d'un plateau pivotant de la même finition.

The round version can be complemented with a swivel top in the same finish.

En la versión redonda, se puede complementar con un sobre giratorio en el mismo acabado.



Collection ALLIAGE Rondes - Round - Ronda

design Andrea CASATI

rochebobo
PARIS



Table de repas ronde avec plateau réalisé en composite céramique/verre (nombreuses finitions). support plateau et piétement en acier finition laque époxy.
Fabrication européenne.

Round dining table with top in ceramic composite /glass (many finishes available). Aluminum crossbar and steel base with epoxy lacquer finish.
Manufactured in Europe

Mesa de comedor redonda con sobre realizado en composite de cerámica/cristal (varios acabados). Traversa de aluminio y pata de acero en acabado lacado epoxi.
Fabricación europea.

Collection ALLIAGE Rondes - Round - Ronda

design Andrea CASATI

rochebobo
PARIS

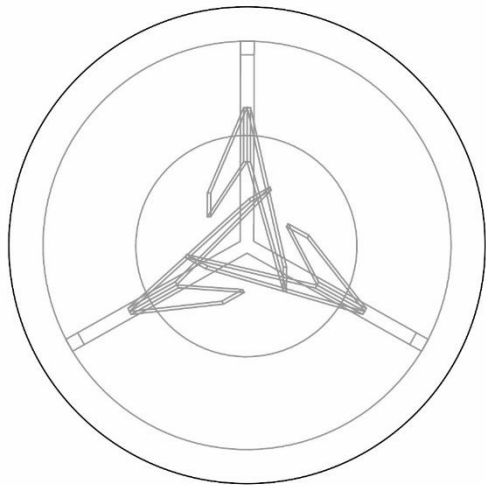

1400 [55"]

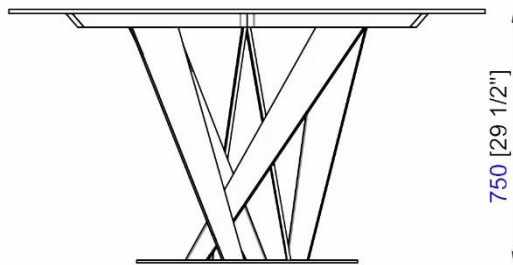

750 [29 1/2"]

375 [14 3/4"] 650 [25 1/2"] 375 [14 3/4"]

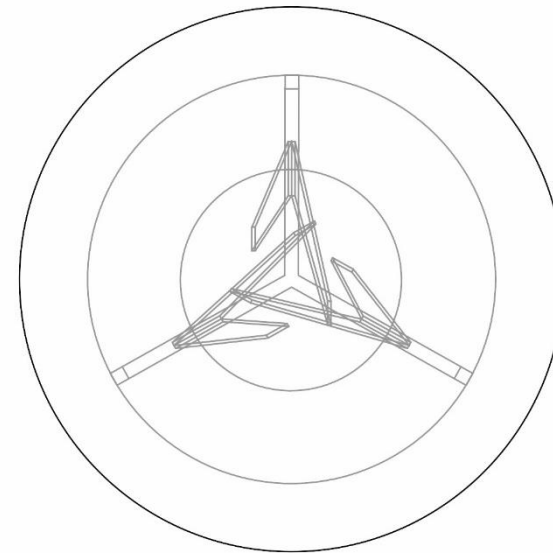

1600 [63"]

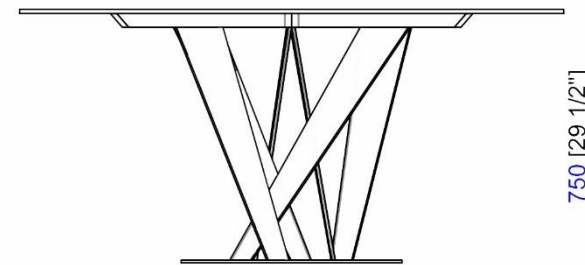

750 [29 1/2"]

475 [18 3/4"] 650 [25 1/2"] 475 [18 3/4"]

Collection ALLIAGE Rondes - Round - Ronda

design Andrea CASATI

rochebobo
PARIS

Finitions disponibles - Finishes availables- Abacados disponibles

Céramiques 5 mm

Pietra

finitions mates / matte finishes
Acabados mate

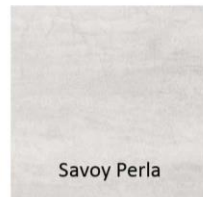

Absolu

finitions mates / matte finishes
Acabados mate

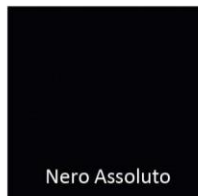

Marmi

finitions brillantes - glossy finishes
Acabados brillantes

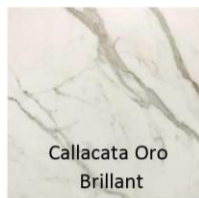
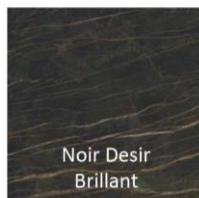

Marmi

finitions mates / matte finishes
Acabados mate



Céramiques 6 mm

Marmi

finitions brillantes - glossy finishes
Acabados brillantes

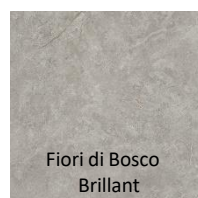

Marmi

finitions mates / matte finishes
Acabados mate

