

ENVERGURE

design Philippe BOUIX

rocheboboiss
PARIS



ENVERGURE

design Philippe BOUIX

rochebobois
PARIS



ENVERGURE

design Philippe BOUIX

rochebobois
PARIS



ENVERGURE

design Philippe BOUIX

rochebobois
PARIS



COMPOSITION 3 ELEMENTS / 3-ELEMENTS

- 29 Grand bâtard 3 places acc. Gauche
Large 3-seat 1-arm unit left armrest
Gran batard 3 plazas apoy. Izquierdo
- 04 Angle panoramique
Panoramic corner
Gran angulo
- 30 Grand bâtard 3 places acc. Droit
Large 3-seat 1-arm unit right armrest
Gran batard 3 plazas apoy. Derecho

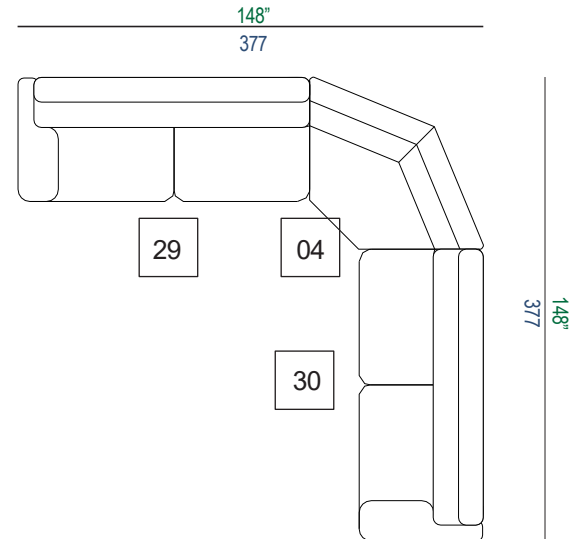

ENVERGURE

design Philippe BOUIX

rocheboboib
PARIS



Fauteuil Pivotant
Swivel Armchair
Sillón Giratorio



Fauteuil fixe 4 pieds
4-legs fixed armchair
Sillón fijo 4 patas

ENVERGURE

design Philippe BOUIX

rochebobois
PARIS



INFORMATIONS TECHNIQUES / TECHNICAL SPECIFICATIONS / FICHA TECNICA:

Structure: Métal, sapin massif, multiplis de peuplier (CARB, bois FSC)
Suspension: Sangles élastiques entrecroisées
Garnissage dossier : Mousse polyuréthane 25kg/m³ et fibres polyester
Garnissage assise: Mousse polyuréthane bi-densité 35-18 kg/m³ et fibres polyester
Garnissage accoudoirs : Mousse polyuréthane bi-densité 25-18 kg/m³ et fibres polyester
Piètement: Métal

Structure: Metal, solid fir wood, poplar plywood (CARB, FSC wood)
Suspension: Cross-webbing elastic straps
Back cushions: Polyurethane foam 25kg/m³ and polyester fibres
Seat cushions: Bi-density polyurethane foam 35-18 kg/m³ and polyester fibres
Arm cushions: Bi-density polyurethane foam 25-18 kg/m³ and polyester fibres
Legs: Metal

Estructura: Metal, abeto macizo, multulaminado de álamo (CARB, madera FSC)
Suspensión: Cinchas elásticas entrecruzadas
Relleno respaldo: Espuma poliuretano 25 kg/m³ y fibras de poliéster
Relleno asiento: Espuma poliuretano bi-densidad 35-18 kg/m³ y fibras de poliéster
Relleno apoyabrazos : Espuma poliuretano bi-densidad 25-18 kg/m³ y fibras de poliéster
Patas: Metal

OPTIONS / OPTIONAL / OPCIONES:

- Tête à tête
- Confort normal ou ferme
- Headrest
- Standard or firm comfort
- Reposacabezas
- Confort normal o firme

OBSERVATIONS / OBSERVATIONS / OBSERVACIONES:

- Fabrication Européenne
- Base disponible en 2 versions : Bois apparent, hêtre massif teinté Noyer foncé, Wengé, Anthracite ou Castor ou Gainée de cuir ou de tissu (voir page 7)
- Piètement métal du fauteuil fixe pieds patins disponible dans 2 finitions : Laque noire ou Aluminium brossé (voir page 7)
- Piètement métal des fauteuils fixe 4 pieds et pivotant disponible uniquement en finition Laque noire (voir page 7)
- Modèle réalisable dans l'ensemble des revêtements de la collection ROCHE BOBOIS
- Dossiers démontables pour la livraison
- Made in Europe
- Base available in 2 versions: Exposed solid beech wood with dark Walnut, Wengé, Anthracite or Castor stain finish or upholstered in leather or fabric (see page 7)
- Metal base for the fixed armchair with glides available in 2 finishes: Black lacquer or Brushed aluminium (see page 7)
- Metal base for the fixed 4-leg or swivel armchairs available only in Black lacquer finish (see page 7)
- Model available in all exclusive materials from the ROCHE BOBOIS collection
- Removable back frame for deliveries
- Fabricación europea
- Base disponible en 2 versiones: Madera de haya maciza a la vista, acabado Nogal oscuro, Wengé, Antracita o Castor o tapizada de piel o de tela (ver página 7)
- Base de metal para sillón fijo con patines disponible in 2 acabados: Lacado negro o Aluminio cepillado (ver página 7)
- Base de metal para sillones fijos de 4 patas y giratorios disponible únicamente en acabado Lacado negro (ver página 7)
- Modelo realizable en el conjunto de los revestimientos de la colección ROCHE BOBOIS
- Respaldos desmontables para la entrega

ENVERGURE

design Philippe BOUIX

rochebobois
PARIS

FINITIONS BASE BOIS / WOODEN BASE FINISH / ACABADO BASE MADERA



Teinte Noyer foncé
Dark Walnut stain
Tinte Nogal oscuro



Teinte Wengé
Wengé stain
Tinte Wengé



Teinte Anthracite
Anthracite stain
Tinte Antracita



Teinte Castor
Castor stain
Tinte Castor

FINITIONS PIETEMENT / LEG FINISH / ACABADO PATAS



Metal Finition Laque Noir
Metal with Black Lacquer
Metal acabado Negro



Aluminium Brossé
Brushed Aluminium Finish
Aluminio Cepillado

ENVERGURE

design Philippe BOUIX

rocheboboib
PARIS

SX Canapé 5 places
5-seat sofa
Sofá 5 plazas

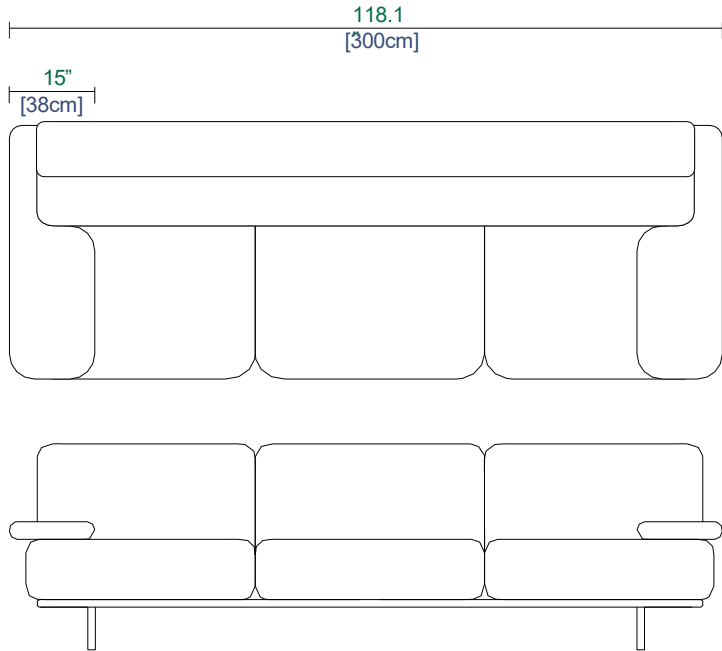

X Canapé 4 places
4-seat sofa
Sofá 4 plazas

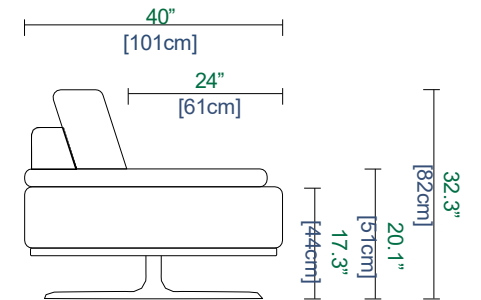
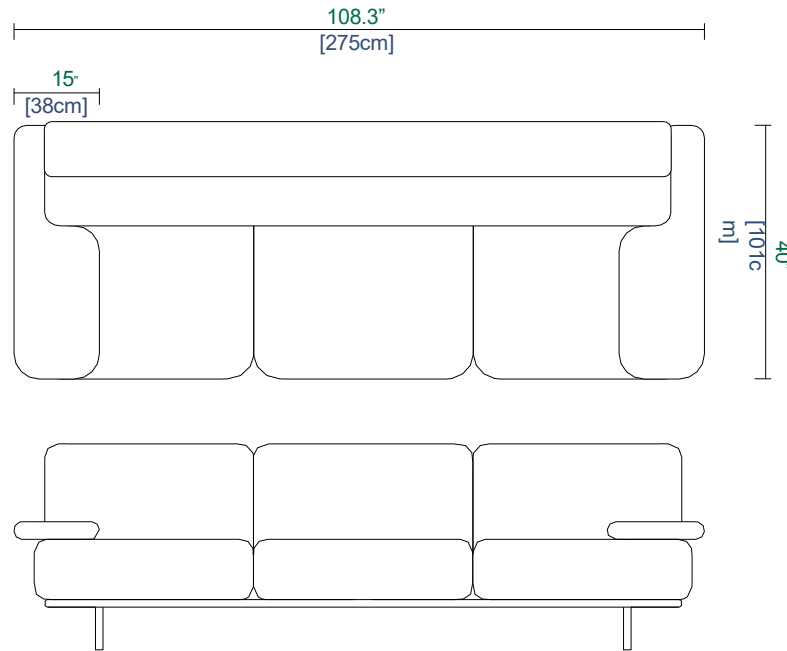

ENVERGURE

design Philippe BOUIX

rocheboboib
PARIS

3 Canapé 3/4 places
3/4-seat sofa
Sofá 3/4 plazas

1 Grand Canapé 3 places
Large 3-seat sofa
Gran Sofá 3 plazas

100.4
[255cm]

15"
[38cm]

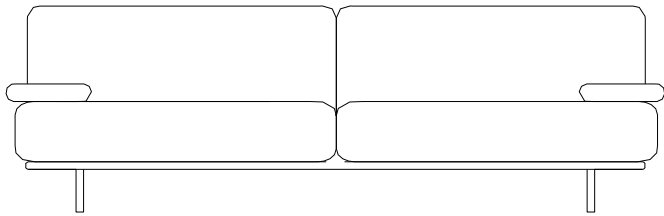
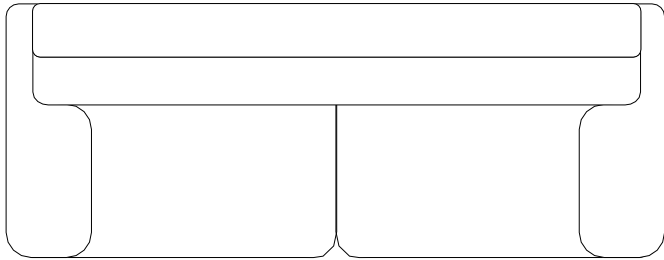

94"
[240cm]

15"
[38cm]

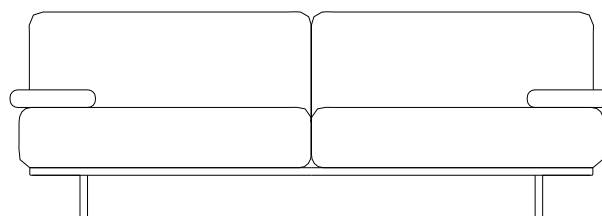
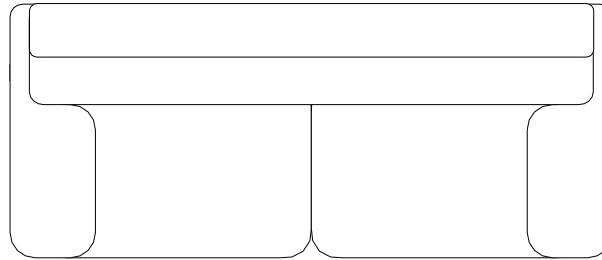

40"
[101cm]

40"
[101cm]

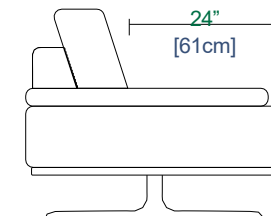

24"
[61cm]

32.3"
[82cm]
20.1"
[51cm]
17.3"
[44cm]

ENVERGURE

design Philippe BOUIX

rochebobois
PARIS

2 Canapé 3 places
3-seat sofa
Sofá 3 plazas

84.6"
[215cm]

15"
[38cm]

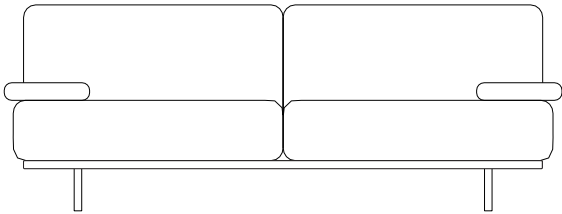
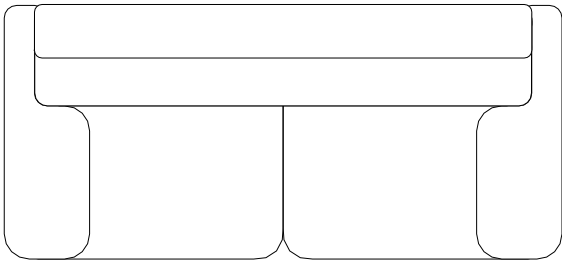

N Canapé 2 1/2 places
2.5 Seat sofa
Sofá 2 plazas 1/2

76.8"
[195cm]

15"
[38cm]

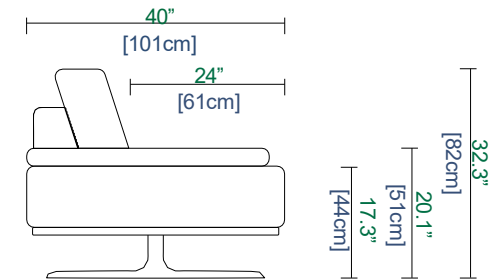
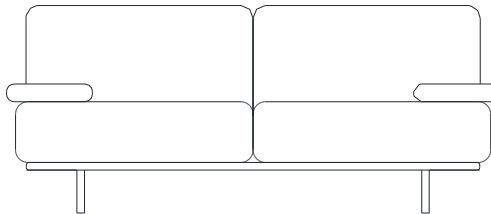
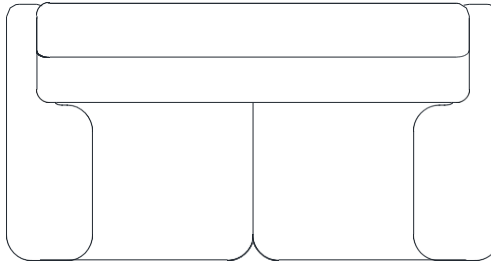

ENVERGURE

design Philippe BOUIX

rochebobo
PARIS

1 Fauteuil
Armchair
Sillón

39.3"
[100cm]
10.2"
[26cm]

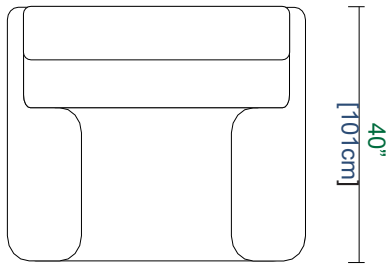

40"
[101cm]

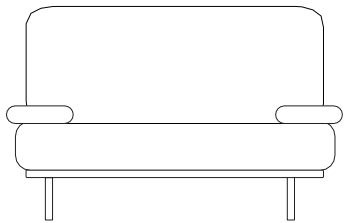

40"
[101cm]
24"
[61cm]

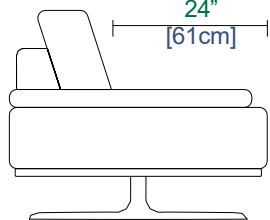

32.3"
[82cm]
20.1"
[51cm]
17.3"
[44cm]

1PF Fauteuil fixe
Fixed Armchair
Sillón

36.2"
[92cm]
4.3"
[11cm]

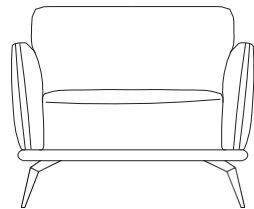
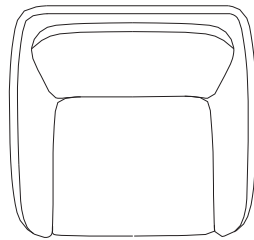

33.8"
[86cm]
20.5"
[52cm]

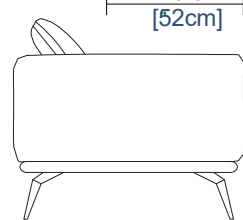

29.5"
[75cm]
24.4"
[62cm]
17.3"
[44cm]

1PG Fauteuil Pivotant
Swivel Armchair
Sillón Giratorio

36.2"
[92cm]
4.3"
[11cm]

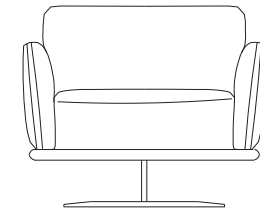
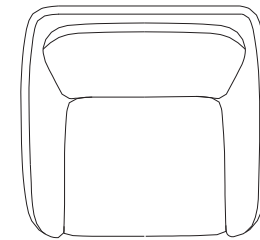

33.8"
[86cm]
20.5"
[52cm]

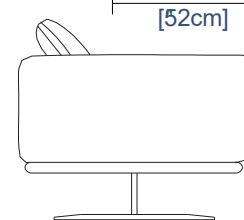

29.5"
[75cm]
24.4"
[62cm]
17.3"
[44cm]

ENVERGURE

design Philippe BOUIX

rocheboboib
PARIS

29 Grand bâtard 3 places acc. Gauche
Large 3-seat 1-arm unit left armrest
Gran batard 3 plazas apoy. Izquierdo

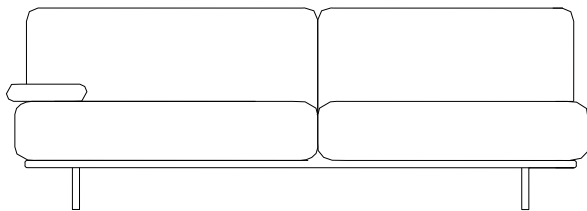
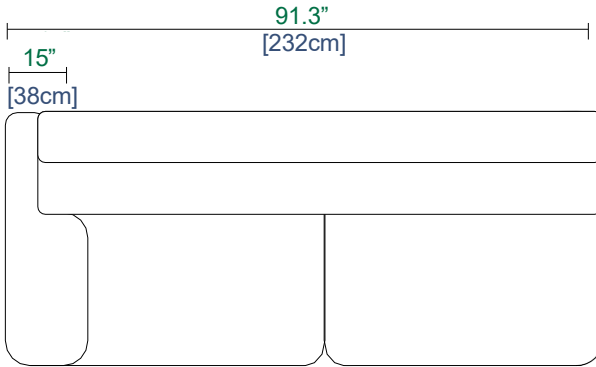

30 Grand bâtard 3 places acc. Droit
Large 3-seat 1-arm unit right armrest
Gran batard 3 plazas apoy. Derecho

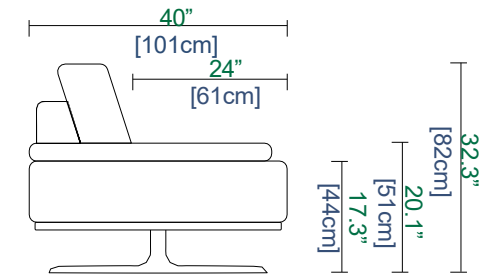
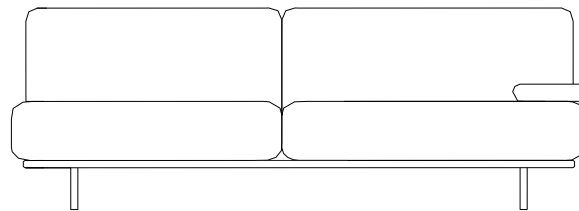
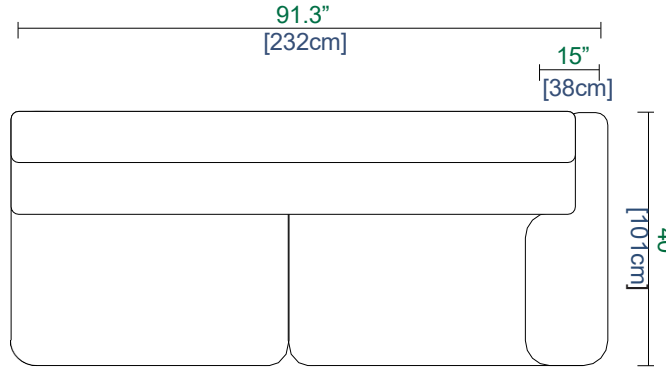

ENVERGURE

design Philippe BOUIX

rochebobois
PARIS

19 Bâtard 3 places acc. Gauche
3-seat 1-arm unit left armrest
Batard 3 plazas apoy. Izquierdo

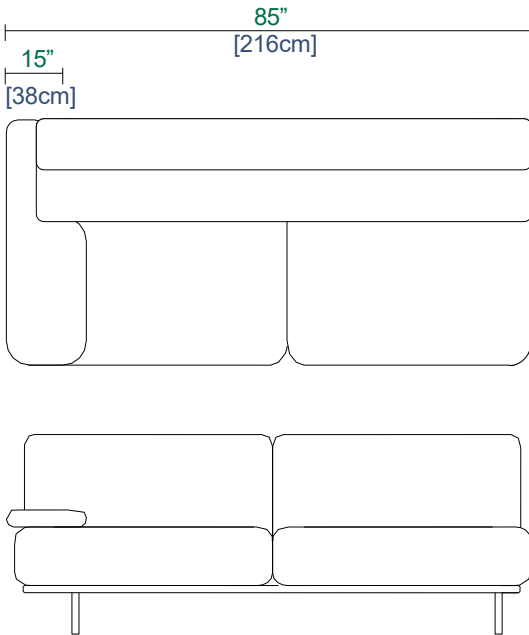

20 Bâtard 3 places acc. Droit.
3-seat 1-arm unit right armrest
Batard 3 plazas apoy. Derecho

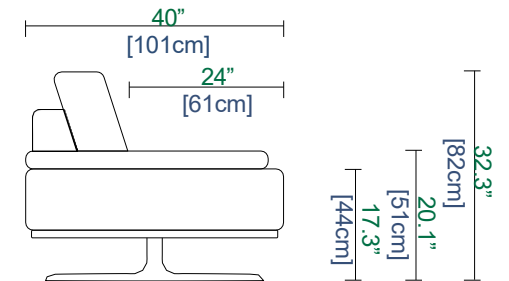
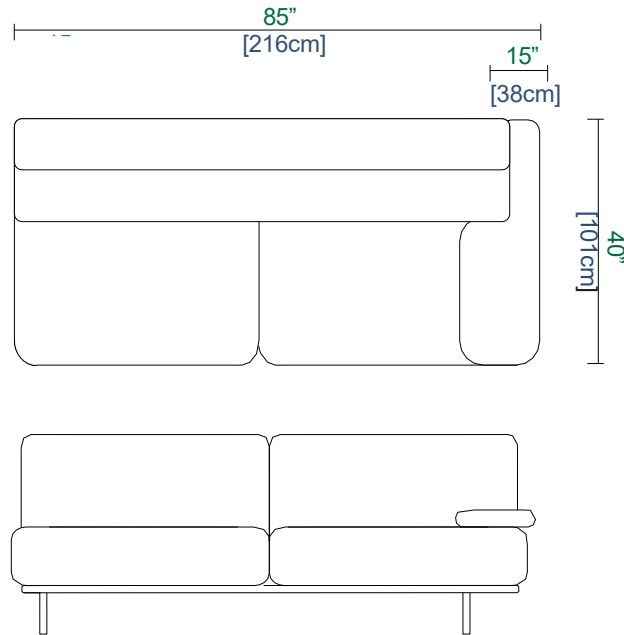

ENVERGURE

design Philippe BOUIX

rochebobois
PARIS

07 Bâtard 2,5 places acc. Gauche
2.5 seat 1-arm unit left armrest
Batard 2,5 plazas apoy. Izquierdo

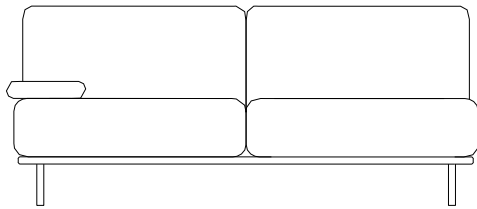
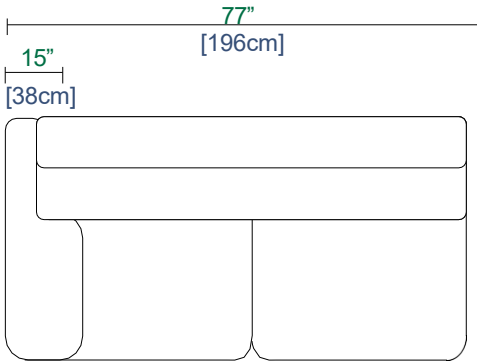

08 Bâtard 2,5 places acc. Droit.
2.5 seat 1-arm unit right armrest
Batard 2,5 plazas apoy. Derecho

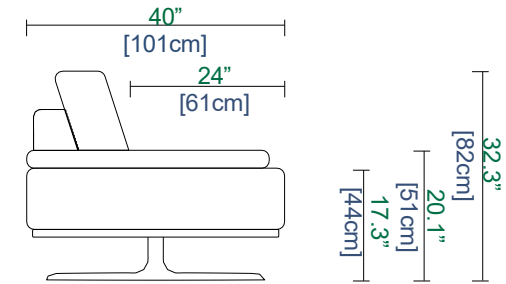
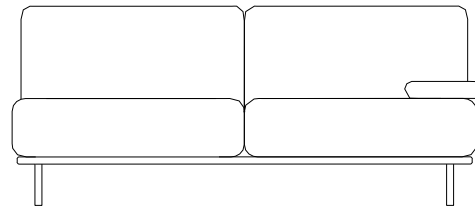
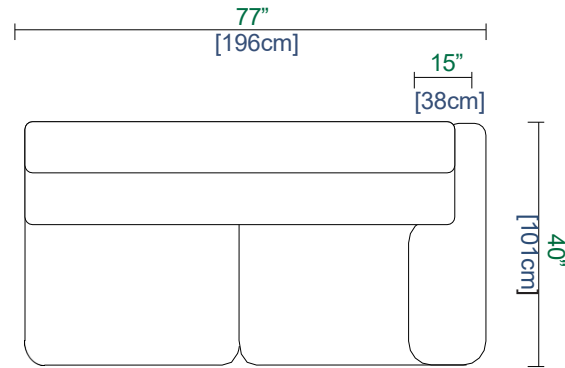

ENVERGURE

design Philippe BOUIX

rochebobo
PARIS

04 Angle panoramique
Panoramic corner
Gran angulo

P Pouf
Ottoman
Puf

RPT Tête
Headrest
Reposacabezas

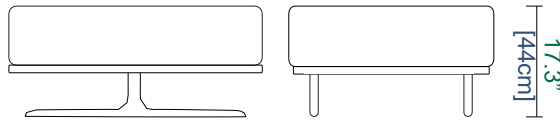
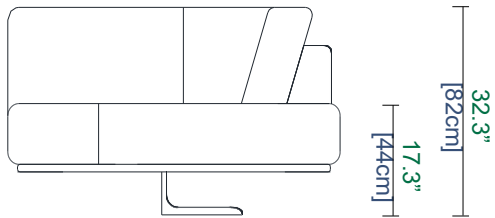
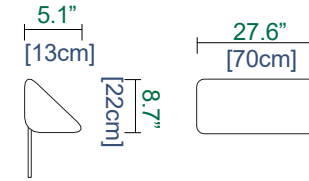
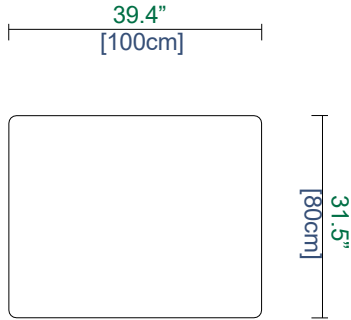
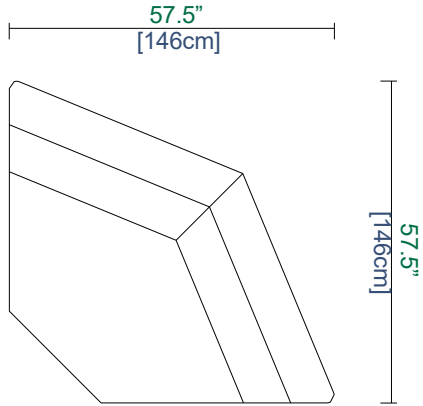

La structure de ce canapé est certifiée FSC™ mixte. Elle est composée de matériaux provenant de forêts certifiées FSC™ gérées de façon responsable et d'autres sources contrôlées.
This sofa's structure has FSC™ Mix certification. It is made with a mixture of materials from responsibly managed, FSC™-certified forests and from other controlled sources.
La estructura de este sillón está certificada FSC™ mixto. Esta compuesta de materiales provenientes de bosques certificados FSC™ gestionados responsablemente y de otras fuentes controladas.